



AirChek® 52 Sample Pump

Cat. No. 224-52
Operating Instructions

863 Valley View Road, Eighty Four, PA 15330 USA • Tel: 724-941-9701 • www.skcinc.com

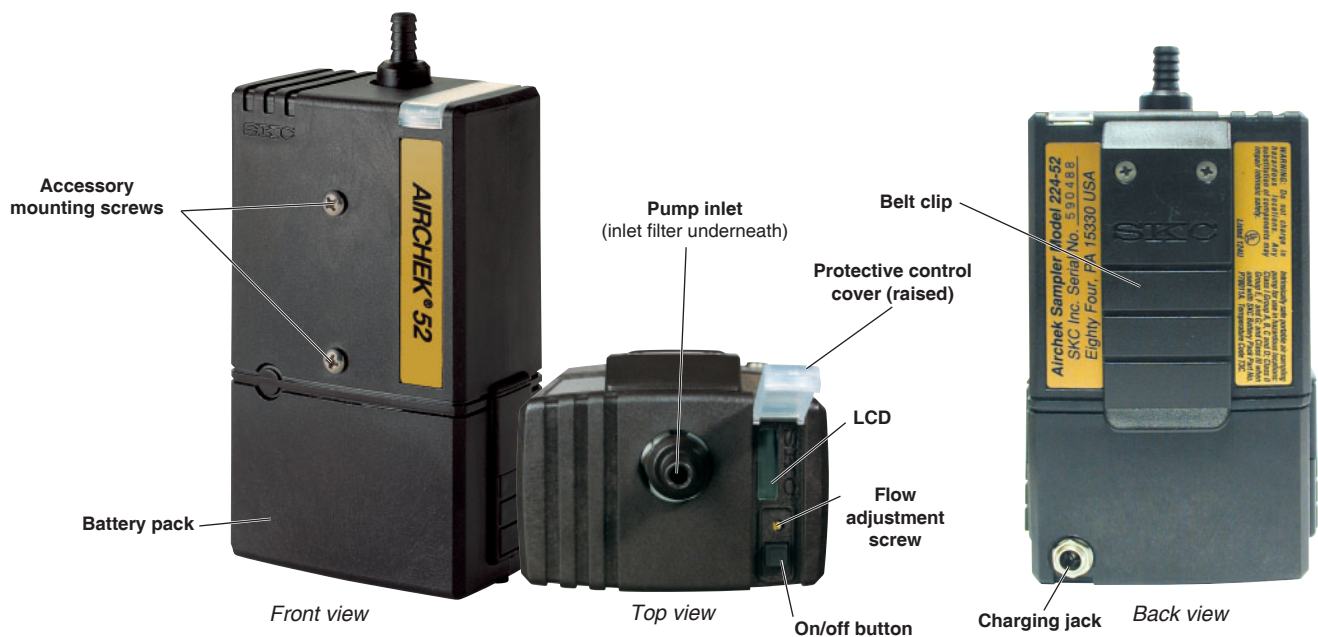

Figure 1. AirChek 52 Sample Pump

Introduction

Description

The AirChek 52 Sample Pump (Figure 1) is designed for rugged industrial use at flows from 5 to 3000 ml/min. Ideal for on-worker applications, use the AirChek 52 for short-term or full-shift sampling with sorbent tubes, impingers, cyclones, PPIs, or filter cassettes.

Checking Pump/Kit Contents

Use the table below to verify that you received all items associated with the Cat. No. ordered. If you are missing items, contact SKC at 800-752-8472 (U.S. only) or 724-941-9701.

If You Ordered Cat. No.	Your Package Should Contain
224-52	AirChek 52 Sample Pump with NiMH battery pack and screwdriver set
224-52-S	AirChek 52 Sample Pump with NiMH battery pack and screwdriver set, single PowerFlex charger with cable, Tygon tubing (3 feet, 1/4-inch ID), and collar clip with cable tie
224-52K	AirChek 52 Sample Pump with NiMH battery pack and screwdriver set, single PowerFlex charger with cable, filter cassette holder, Tygon tubing (3 feet, 1/4-inch ID), and soft-sided nylon carry case

Required Equipment

- 1/4-inch ID tubing
- PowerFlex® Charger
- Low flow accessories if sampling at 5 to 500 ml/min. *See Accessories.*

Getting Started

Charge the Battery Pack

 For optimum charge, ensure that the pump is not running.

1. Activate the charger (follow *PowerFlex Operating Instructions 40069*).
2. Insert the charging cable connector into the charging port on the charger. See right.
3. Insert the charging plug end of the cable into the jack on the back of the pump's battery pack (Figure 1).
4. Charge the battery completely (the LED at the port connected to the pump is a steady green) before using the pump.
5. Disconnect the charging cable from the back of the pump's battery pack.

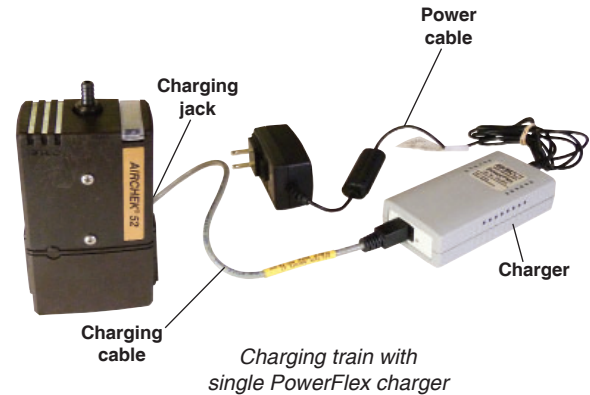

Notes and Cautions

- To comply with intrinsic safety regulations, do not charge or operate the pump from the charger in hazardous locations.
- Using a non-approved charger voids any warranty.
- Using a repaired or rebuilt battery pack voids any warranty and the UL Listing for intrinsic safety.
- Using any device other than the approved battery pack to power the pump voids the UL Listing for intrinsic safety and any warranty.
- Ensure proper orientation of charging cable before plugging it into the charging jack. Improper orientation/contact will short-circuit the battery and voids any warranty.
- Short-circuiting the battery pack will render it immediately inoperative.
- Failure to follow warnings and cautions voids any warranty.
- The battery pack may be kept on the SKC-approved charger for an indefinite time.

For more information on SKC pump battery packs, visit www.skcinc.com/catalog/pdf/instructions/1756.pdf.

Use the Pump with AC Power (Power option in non-hazardous locations)

 **Do not use the pump with the Battery Eliminator in hazardous locations. UL Listing for intrinsic safety is not in effect during pump operation with the Battery Eliminator.**

The Battery Eliminator is an accessory that converts alternating current (AC) to direct current (DC) from which the pump can be operated for extended runs. **The Battery Eliminator should be used in non-hazardous locations only.** See *Accessories*.

1. Remove the battery pack from the pump. See *Replace the Battery Pack*.
2. The Battery Eliminator is comprised of two pieces, a wall cube and a power adapter. Plug the wall cube into a standard wall outlet and insert its plug end into the power adapter.
3. Fit the power adapter on the pump in place of the battery pack.

Operation

High Flow Applications (1000 to 3000 ml/min)

Set/Calibrate Flow Rate

- Allow pump to equilibrate after moving it from one temperature extreme to another.
 - Charge battery completely before calibration and sampling.
1. Ensure that the battery is fully charged and that the pump has run for five minutes before calibrating. Leave the pump running.
 2. Prepare the calibrator. *See calibrator instructions.*
 3. Set up a calibration train: Using flexible tubing, connect the calibrator outlet (suction port) to the representative sample medium inlet. Using ¼-inch Tygon tubing, connect the sample medium outlet to the pump inlet. *See right.*
 4. Using a screwdriver, set the pump flow rate by turning the flow adjustment screw on top of the pump (*Figure 1*), **clockwise** to increase or **counterclockwise** to decrease flow, until the calibrator indicates the method-specified flow rate. Take a minimum of three readings and record the average flow rate, as per OSHA/NIOSH instructions.
 5. Press the on/off button to turn off the pump. Disconnect the calibrator and flexible tubing from the representative sample medium and proceed to *Set Up/Sample*.

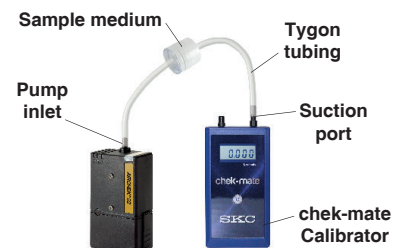

Calibration train with filter cassette

Set Up/Sample

- Allow pump to equilibrate after moving it from one temperature extreme to another.
 - Protect sample pump from weather when sampling outdoors.
 - Powering the pump with any device other than the approved battery pack voids the UL Listing for intrinsic safety.
 - Do **not** use the pump with the Battery Eliminator in hazardous locations. UL Listing for intrinsic safety is not in effect during pump operation with Battery Eliminator.
 - Use of any device other than the approved battery pack or Battery Eliminator to power the pump voids any warranty.
 - Charge battery completely before calibration and sampling.
1. Replace the representative sample medium with new unexposed medium for sample collection.
 2. Place the sample medium where appropriate for sampling.
 - a. For **personal sampling**, clip the sample collection medium to the worker in the breathing zone and the pump to the worker's belt using the belt clip.
 -  **When using an impinger, an in-line trap (SKC Cat. No. 225-22 or 225-22-01) is required between the pump and impinger to prevent fumes from accidentally being drawn into the sampler. Failure to use an appropriate in-line trap during impinger sampling voids any warranty.**
 - b. For **sampling with an impinger**, mount the single or dual impinger and trap (SKC Cat. No. 225-20-01 or 225-20-02) to the face of the sampler using the accessory mounting screws (*Figure 1*) or place them in a holster at the worker's waist.
 3. Press the on/off button to clear the elapsed time displayed on the LCD and to start sampling. Record the start time and other pertinent information. The LCD will automatically display elapsed pump run time. *See below.*



Clip sample medium to worker and pump to belt.



Impinger holder on pump with impinger and trap

Possible Displays During Sampling

Flow or Battery Fault Shutdown - If the pump is unable to compensate due to excessive back pressure or a low battery condition exists, it will shut down and timing functions will pause. The LCD will display either a battery-shaped icon or a flow fault icon (→I) depending on the cause of the shutdown. Upon flow fault, the pump will attempt to restart up to five times. To restart from flow fault, correct the blockage and press the on/off button twice. **The elapsed run time display will reset to 0 when the pump is restarted.** If the battery icon is displayed, recharge the battery before sampling.

Displayed Elapsed Run Time - Elapsed run time is displayed continuously on the LCD. For elapsed times after 999 minutes, the display still shows elapsed time but alternates between displaying the first two digits of the elapsed time and the last three digits. For example, a pump that has run for 1,440 minutes would display first "01" and then "440." The display maximum is 99 999, which is 99,999 minutes.

4. At the end of the sampling period, press the on/off button and record stop time and other pertinent information.

High Flow Applications (Cont)

5. Cap the sample and send it with blanks and pertinent sampling information to a laboratory for analysis.
6. Verify the flow.
 - a. Turn on the pump and reinstate the calibration train and sample medium.
 - b. Take three readings and record the average value as the post-sample flow rate. **Do not adjust the pump flow rate during this step.**
 - c. Compare the pre and post-sample flow rates. Note in sampling documentation if the values differ by more than $\pm 5\%$.

Low Flow Applications (5 to 500 ml/min)

- Single-tube sampling requires the All-in-One Low Flow Holder; see the operating instructions for the All-in-One for details on its operation.
- Multiple-tube sampling requires a Constant Pressure Controller (CPC) and a Dual, Tri, or Quad Adjustable Low Flow Tube Holder accessory; see the operating instructions for the CPC and Adjustable Low Flow Tube Holder for details on their operation.

Using the All-in-One Low Flow Holder (Figure 2)

Set/Calibrate Flow Rate for Single Tube

- Allow pump to equilibrate after moving it from one temperature extreme to another.
- Charge pump battery completely before calibration and sampling.
- Calibrate/verify pump flow rate before and after each sampling operation using the tube holder and pump to be used for sampling.
- Set the flow rate through the pump first and then calibrate the flow rate through the representative sorbent tube.
- Two small inlet holes on the bottom of the built-in CPC of the All-in-One can become blocked. Periodically inspect and, if needed, clean with a small pick and blow particles away with a puff of air.

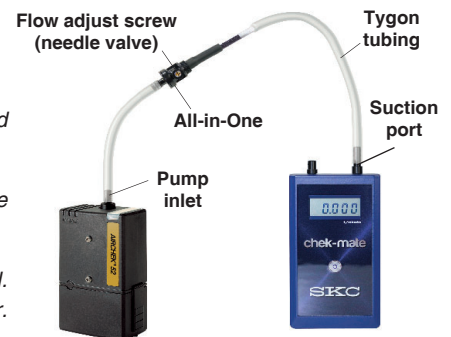

Calibration train with All-in-One Low Flow Holder connected to AirChek 52

Pump Flow Rate

1. Ensure that the battery is fully charged and that the pump has run for 5 minutes before calibrating. Leave the pump running.
2. Prepare the calibrator (see calibrator instructions). Using flexible tubing, connect the calibrator outlet (suction port) to the pump inlet.
3. Set the pump flow rate to 1.5 L/min. Using a small screwdriver, turn the flow adjustment screw on top of the pump (Figure 1), **clockwise** to increase flow or **counterclockwise** to decrease flow, until the calibrator indicates 1.5 L/min.
4. Remove tubing from the pump inlet.

Flow Rate Through Sorbent Tube

1. Attach the Tygon tubing of the All-in-One to the pump inlet. **Note:** If the pump flow faults shortly after the holder is attached, check that the needle valve is open by using a small flat-head screwdriver to turn the flow adjust screw on the holder **slightly** counterclockwise. If flow fault continues, check that the two small holes on the bottom of the built-in CPC are not blocked. If needed, clean them with a small pick and blow any particles away with a puff of air.
2. Break tips off the representative sorbent tube and insert it into the rubber sleeve on the All-in-One (**arrow on the tube points toward the holder**). **Note:** Ensure that the sorbent tube fits snugly in the rubber sleeve prior to sampling to avoid air leakage. Two sleeves, each with a different inner diameter, are supplied with the All-in-One.
3. Using flexible tubing, connect the calibrator outlet to the inlet of the representative sorbent tube in the holder. See calibration train above right.

 **In the next step, do not shut off flow completely with flow adjust screw or use an oversize screwdriver to adjust flow — valve or thread seat damage may result.**

4. **Do not adjust the flow on the pump.** Adjust the flow rate through the representative sorbent tube using a small flat-head screwdriver to turn the flow adjust screw on the All-in-One (**counterclockwise to increase, clockwise to decrease**) until the calibrator displays the method-specified flow rate. Take a minimum of three readings and record the average flow rate, as per OSHA/NIOSH instructions.
5. When calibration is complete, turn off the pump by pressing the on/off button. Disconnect the calibrator and tubing from the representative sorbent tube inlet.



Turn screw on holder to adjust flow.

Low Flow Applications (Cont)

Set Up/Sample with Single Tube

- Allow pump to equilibrate after moving it from one temperature extreme to another.
 - Protect sample pump from weather when sampling outdoors.
 - Use of any device other than the approved battery pack to power the pump voids the UL Listing for intrinsic safety and any warranty.
 - Charge pump completely before calibration and sampling.
 - Calibrate/verify pump flow rate before and after each sampling operation using the tube holder and pump to be used for sampling.
1. Replace the representative sorbent tube used for calibrating flow with a new unexposed sorbent tube for sample collection. **Note:** Ensure sorbent tube fits snugly in rubber sleeve of the All-in-One before sampling to avoid any air leakage. Two sleeves, each a different inner diameter (ID), are supplied.
 2. Place the tube cover over the tube (Figure 2) and thread it into place on the All-in-One low flow holder.
 3. Place the sorbent tube where appropriate for sampling. **For personal sampling**, clip the sample medium to the worker in the breathing zone and the pump to the worker's belt.
 4. Press the on/off button to clear the elapsed time displayed on the LCD and to start sampling. Record the start time and other pertinent information. The LCD will automatically display elapsed run time. See below.
- Possible Displays During Sampling**

Flow or Battery Fault Shutdown - If the pump is unable to compensate due to excessive back pressure or a low battery condition exists, it will shut down and timing functions will pause. The LCD will display either a battery-shaped icon or a flow fault icon (→I) depending on the cause of the shutdown. Upon flow fault, the pump will attempt to restart up to five times. To restart from flow fault, correct the blockage and press the on/off button twice. **The elapsed run time display will reset to 0 when the pump is restarted.** If the battery icon is displayed, recharge the battery before sampling.

Displayed Elapsed Run Time - Elapsed run time is displayed continuously on the LCD. For elapsed times after 999 minutes, the display still shows elapsed time but alternates between displaying the first two digits of the elapsed time and the last three digits. For example, a pump that has run for 1,440 minutes would display first "01" and then "440." The display maximum is 99 999, which is 99,999 minutes.
5. At the end of the sampling period, press the on/off button and record stop time and other pertinent information.
 6. Cap the sample tube and send it with blanks and pertinent sampling information to a laboratory for analysis.
 7. Verify the flow.
 - a. Turn on the pump and reinstate the calibration train and sample media.
 - b. Take three readings and record the average value as the post-sample flow rate. **Do not adjust the pump flow rate during this step.**
 - c. Compare the pre and post-sample flow rates. Note in sampling documentation if the values differ by more than $\pm 5\%$.



Clip tube holder to worker and pump to belt.

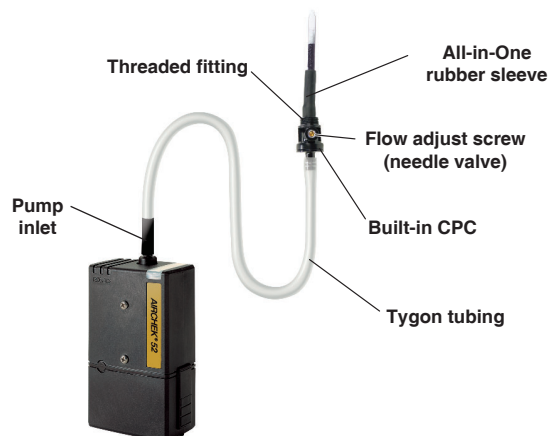

Figure 2. All-in-One Low Flow Holder Connected to AirChek 52

Low Flow Applications (Cont)

Using a CPC and Dual, Tri, or Quad Adjustable Low Flow Tube Holder (Figure 3)

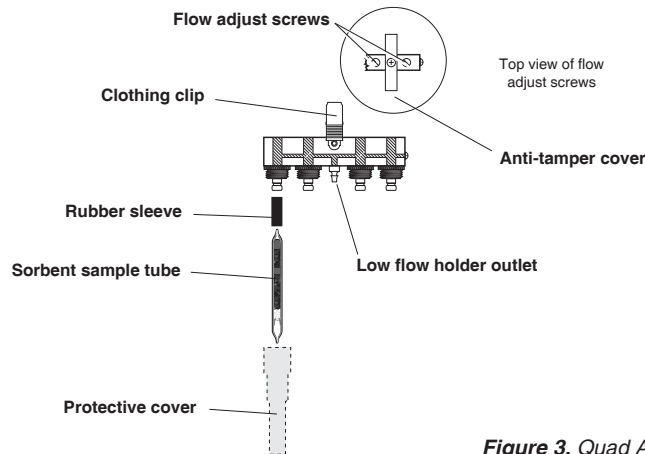

Figure 3. Quad Adjustable Low Flow Tube Holder

Set/Calibrate Flow Rate for Multiple Tubes

- Requires Constant Pressure Controller (CPC) and Adjustable Low Flow Tube Holder (see Accessories). The low flow tube holder used with CPC allows up to four tube samples to be taken simultaneously, each at different flow rates if desired.
- Allow pump to equilibrate after moving it from one temperature extreme to another.
- Charge pump battery completely before calibration and sampling.
- Calibrate/verify pump flow rate before and after each sampling operation using the tube holder and pump to be used for sampling.
- Set the flow rate through the pump first and then calibrate the flow rate through each representative sorbent tube.

Pump Flow Rate

Follow these important steps before proceeding.

1. Ensure that the battery is fully charged and that the pump has run for 5 minutes before calibrating. Leave pump running.
2. Prepare a calibrator (see calibrator instructions). Using flexible tubing, connect the calibrator outlet (suction port) to the pump inlet.
3. Calculate the sum of all tube flow rates. The maximum flow rate through any one tube is 500 ml/min.*
 - a. If the sum is ≤ 1000 ml/min, set the pump flow rate to 1.5 L/min.
 - b. If the sum is > 1000 ml/min, multiply that number by 0.15 and total the two numbers. Set the pump flow rate for the resulting new sum. (Example: Sampling with three sorbent tubes, each with a flow rate of 500 ml/min.* The sum of the tube flow rates is calculated as $3 \times 500 = 1500$. Determining a 15% higher flow rate is calculated as $1500 \times 0.15 = 225$. Calculating the final pump flow setting would be $1500 + 225 = 1725$ ml/min.)

* Back pressure across some sample tubes can be higher than average. In these instances, the maximum flow rate of 500 ml/min per tube may not be achieved.

4. Using a small screwdriver, turn the flow adjustment screw on top of the pump (Figure 1) (clockwise to increase flow or counterclockwise to decrease flow) until the calibrator indicates the required flow rate.
5. Remove tubing from the pump inlet and calibrator outlet.

Flow Rate Through Sorbent Tubes

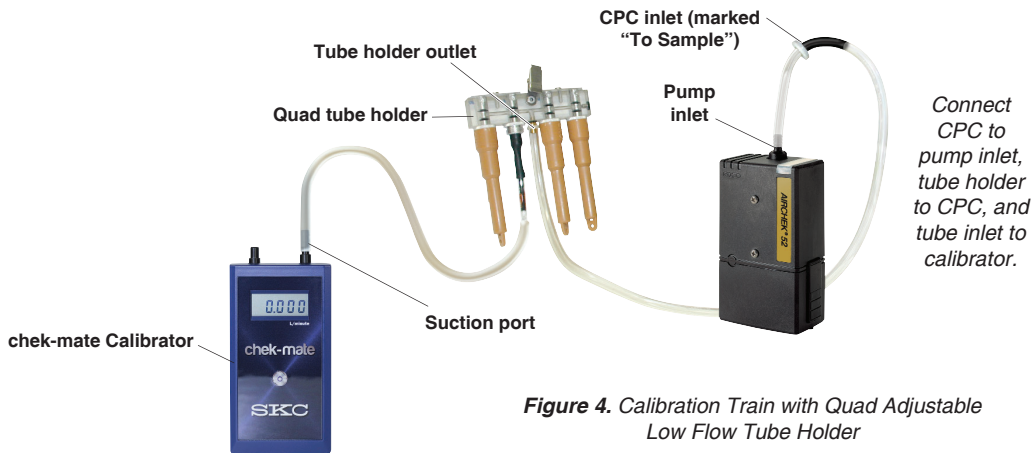

Figure 4. Calibration Train with Quad Adjustable Low Flow Tube Holder

1. Attach the tubing on the CPC outlet (side of the CPC without a label) to the pump inlet. Attach the Adjustable Low Flow Holder to the CPC inlet (marked "To Sample"). See Figure 4.
2. Break tips off the representative sorbent tubes and insert the tubes into the rubber sleeves on the holder (**arrow on each tube pointing toward pump**). Place unopened tubes in any unused ports to "seal" them.
3. Label all representative tubes and ports.
4. Using flexible tubing, connect the exposed end of the first active tube to be calibrated to the calibrator outlet (suction port).
5. Using a small screwdriver, loosen and turn the brass flow adjust screw (see above right) directly beneath the port holding the first active tube to be calibrated (**clockwise** to increase, **counterclockwise** to decrease) until the calibrator indicates the method-specified flow rate. **Do not adjust the flow rate on the pump.** Note: For tri and quad models, first rotate each anti-tamper cover to expose the flow adjust screws, then adjust the appropriate one until the calibrator indicates the desired flow (Figures 3 and 5).
6. Repeat Steps 4 and 5 for each active representative tube. Note: Changing the flow on one tube will **not** affect the flow rate through the remaining tubes.
7. Once flow is calibrated for each active tube, it is recommended practice to re-check the flow rate through representative tubes before removing them. Any adjustment should be minimal.

Flow adjust screws



Turn screw on tube holder to adjust flow.

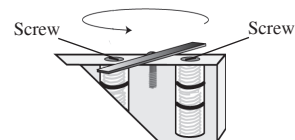

Figure 5. Cut-away of Tri/Quad Adjustable Low Flow Tube Holder

Set Up/Sample with Multiple Tubes

- Requires Constant Pressure Controller (CPC) and Adjustable Low Flow Tube Holder (see Accessories). The low flow tube holder used with CPC allows up to four tube samples to be taken simultaneously, each at different flow rates if desired.
- Allow pump to equilibrate after moving it from one temperature extreme to another.
- Protect sample pump from weather when sampling outdoors.
- Use of any device or battery pack other than P85004 or P84002 to power the pump voids the UL Listing for intrinsic safety.
- Charge pump completely before calibration and sampling.
- Calibrate/verify pump flow rate before and after each sampling operation using the tube holder and pump to be used for sampling.

1. Replace the representative sorbent tubes used for calibration with new unexposed sorbent tubes for sample collection.
2. Place a protective tube cover over each tube and thread into place on holder until secure.
3. Place the adjustable holder with tubes where appropriate for sampling. **For personal sampling**, clip the low flow tube holder to the worker in the breathing zone and the pump to the worker's belt.
4. Press the on/off button to clear the elapsed time displayed on the LCD and to start sampling. Record the start time and other pertinent information. Sample for the time specified in the method used. The LCD will automatically display elapsed run time.



Clip tube holder to worker and pump to belt.

Possible Displays During Sampling

Flow or Battery Fault Shutdown - If the pump is unable to compensate due to excessive back pressure or a low battery condition exists, it will shut down and timing functions will pause. The LCD will display either a battery-shaped icon or a flow fault icon (→I) depending on the cause of the shutdown. Upon flow fault, the pump will attempt to restart up to five times. To restart from flow fault, correct the blockage and press the on/off button twice. **The elapsed run time display will reset to 0 when the pump is restarted.** If the battery icon is displayed, recharge the battery before sampling.

Displayed Elapsed Run Time - Elapsed run time is displayed continuously on the LCD. For elapsed times after 999 minutes, the display still shows elapsed time but alternates between displaying the first two digits of the elapsed time and the last three digits. For example, a pump that has run for 1,440 minutes would display first "01" and then "440." The display maximum is 99 999, which is 99,999 minutes.

5. At the end of the sampling period, press the on/off button and record stop time.
6. Cap the sample tubes and send with blanks and pertinent sampling information to a laboratory for analysis.
7. Verify the flow.
 - a. Turn on the pump and reinstate the calibration train and sample media.
 - b. Take three readings and record the average value as the post-sample flow rate. **Do not adjust the pump flow rate during this step.**
 - c. Compare the pre and post-sample flow rates. Note in sampling documentation if the values differ by more than $\pm 5\%$.

Maintenance

Replace the Pump Inlet Filter

The AirChek 52 Sampler is fitted with a filter/trap just below the pump inlet. This prevents particles from being drawn into the pump mechanism. The filter should be replaced periodically as follows:

1. Grip the inlet fitting (*see right*) and turn it counterclockwise to unthread it.
2. Holding the pump upside down, use a small flat-head screwdriver or tweezers to remove the filter.
3. Place a new filter in the inlet. Ensure that the rubber gasket inside the inlet fitting is still in place.
4. Thread the inlet fitting back into place.



Replace the Battery Pack

 **Use of a repaired or rebuilt battery pack voids any warranty and the UL Listing for intrinsic safety.**

1. Loosen two security screws on bottom of pump case and allow them to fall to the out position.
2. Pinch battery pack release arms and pull the bottom half of the pump case away from the top half.
3. Align arms on top half of case with slots on either side of the new battery pack housing. Ensure that the back of the battery pack with the charging jack is on the same side as the belt clip.
4. Slide battery pack up until arms click into place.
5. Push each security screw into the battery pack housing and tighten.

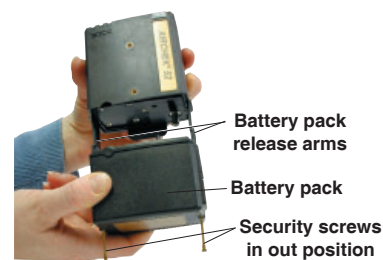

 **Once installed, completely charge the new battery pack before operating the pump (*see Charge the Battery Pack*). It may be necessary to charge it a few times before achieving maximum battery capacity.**

For information on SKC pump battery packs, visit <http://www.skcinc.com/instructions/1756.pdf>.

Pump Service

Pumps under warranty should be sent to SKC Inc. for servicing. *See Limited Warranty and Return Policy.*

Accessories/Replacement Parts

Accessories	Cat. No.
chek-mate Calibrator with CalChek , 0.50 to 5 L/min, includes 9-volt alkaline battery and NIST-traceable certificate	375-0550N
Low Flow Sampling	
Low Flow (5 to 500 ml/min) Kit includes All-in-One low flow holder and Type A tube cover	210-500
Adjustable Low Flow Tube Holders	
<i>Use with CPC listed below. Require separate tube covers listed below</i>	
Dual Holder	224-26-02
Tri Holder	224-26-03
Quad Holder	224-26-04
Constant Pressure Controller (CPC)	224-26-CPC
Protective Tube Covers for Sorbent Tubes	
<i>Use with adjustable low flow tube holders listed above.</i>	
Type A - 6-mm OD x 70-mm L, included in Low Flow Kit above	224-29A
Type B - 8-mm OD x 110-mm L	224-29B
Type C - 10-mm OD x 150-mm L	224-29C
Type D - 10-mm OD x 220-mm L	224-29D
Battery Maintenance	
PowerFlex Charging System for SKC Personal Pumps	
5-Station , 100-240 V	223-1000
Single , 100-240 V	223-2000
PowerFlex Pump Cable , for AirChek 52	223-1004
Battery Eliminator ,* connects pump to line power for extended sampling, 115 V	223-300
Pump Operation	
Screwdriver Set , included with pump	224-11
Protective Nylon Pouch with belt and shoulder strap	
Black	224-88
High-profile Red	224-96A
Noise-reducing Black	224-96C



* Not UL Listed for intrinsic safety

Replacement Parts

 Use only SKC-approved parts to ensure reliable performance. Failure to do so voids the UL Listing for intrinsic safety and any warranty.

 Use of a repaired or rebuilt battery pack voids any warranty and the UL Listing for intrinsic safety.

 Failure to follow warnings, cautions, and notes voids any warranty.

Internal Stack

No.	Description	Cat. No.
1A/1C	Stack screws, pk/12	P51891
2	Inlet/Hose Connect, includes filter and gasket	P20106
2A	Replacement Inlet Filter, pk/10	P40370
3	Pulsation dampener	P2010802
4	Stack plate	N/A
5A/5B	Valve plates (top and bottom)	P213201
6	Diaphragm/Yoke assembly	P2129B
7	Pump body	P22417G
8	Motor/Eccentric	P518803
9	Pump base plate	P20102
	Full Stack without Motor	P20102A

Parts not indicated in illustration:

N/A	PC Board	P79592
N/A	Screw and O-ring Set (complete for one pump)	P22402

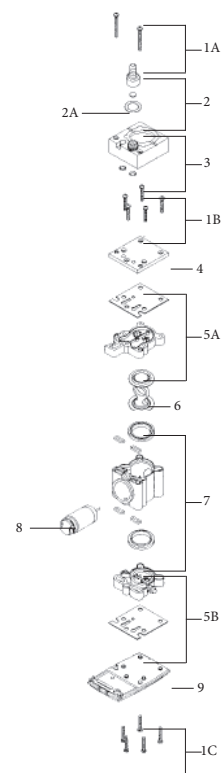

External Case

No.	Description	Cat. No.
1	Battery Pack, NiMH	P78011AMH
2	Battery Pack Release Arms	N/A
3	Battery Pack Security Screws	N/A
4	Compensation Pot A	N/A
5	Compensation Pot B	N/A
6	Power Plug for Battery Pack, pk/5	P20107
7	Charging Jack (on rear of battery pack)	N/A
8	Impinger Holder Mounting Screws	N/A
9	Inlet (includes filter and gasket)	P20106
10	Control Cover	P20105
11	Flow Adjustment Screw	N/A
12	Power Switch (on/off)	N/A
13	Belt Clip (not shown)	P20104
14	LCD	P72391
15	External Case	P2010003

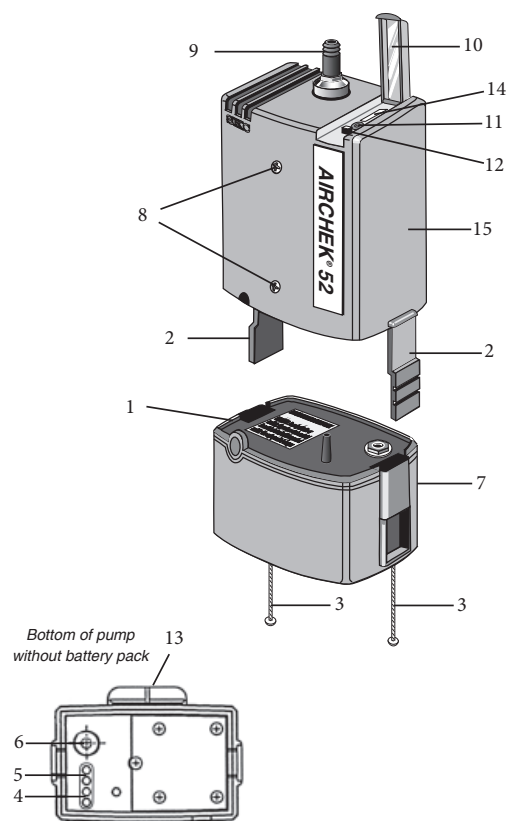

SKC Limited Warranty and Return Policy

SKC products are subject to the SKC Limited Warranty and Return Policy, which provides SKC's sole liability and the buyer's exclusive remedy. To view the complete SKC Limited Warranty and Return Policy, go to <http://www.skcinc.com/warranty>.

Appendix

Performance Profile

Flow Range	1000 to 3000 ml/min <i>5 to 500 ml/min requires low flow accessories. See Accessories.</i>																														
Flow Control	Holds constant flow to $\pm 5\%$ of set-point after calibration																														
Compensation Range <i>(back pressure capability)</i>	1000 ml/min up to 25 inches water back pressure 2000 ml/min up to 25 inches water back pressure 2500 ml/min up to 20 inches water back pressure 3000 ml/min up to 15 inches water back pressure																														
Typical Back Pressure of Sampling Media <i>(inches water)</i>	<table border="1"> <thead> <tr> <th>Flow Rate (L/min)</th> <th>1.0</th> <th>1.5</th> <th>2.0</th> <th>2.5</th> </tr> </thead> <tbody> <tr> <td>Filter/Pore Size (μm)</td> <td></td> <td></td> <td></td> <td></td> </tr> <tr> <td>25-mm MCE/0.8</td> <td>6</td> <td>9</td> <td>12</td> <td>15</td> </tr> <tr> <td>25-mm MCE/0.45</td> <td>14</td> <td>22</td> <td>28</td> <td>35</td> </tr> <tr> <td>37-mm MCE/0.8</td> <td>2</td> <td>3</td> <td>4</td> <td>5</td> </tr> <tr> <td>37-mm PVC/5.0</td> <td>1</td> <td>1</td> <td>2</td> <td>2</td> </tr> </tbody> </table> <p><i>Compare the information in this table to pump compensation range to determine appropriate applications.</i></p>	Flow Rate (L/min)	1.0	1.5	2.0	2.5	Filter/Pore Size (μm)					25-mm MCE/0.8	6	9	12	15	25-mm MCE/0.45	14	22	28	35	37-mm MCE/0.8	2	3	4	5	37-mm PVC/5.0	1	1	2	2
Flow Rate (L/min)	1.0	1.5	2.0	2.5																											
Filter/Pore Size (μm)																															
25-mm MCE/0.8	6	9	12	15																											
25-mm MCE/0.45	14	22	28	35																											
37-mm MCE/0.8	2	3	4	5																											
37-mm PVC/5.0	1	1	2	2																											
Run Time	Nickel-metal hydride (NiMH) battery: 12 hrs minimum at 2000 ml/min and up to 25 inches water back pressure; depends on media used. <i>See Table 1.</i> Battery Eliminator: Pump provides extended runs.																														
Power Supply	Rechargeable 4.8-V NiMH battery pack, 3.3-Ah capacity A Battery Eliminator is available (<i>see Accessories</i>); use voids the UL Listing for intrinsic safety.																														
Battery Charging Time <i>(varies with battery capacity and level of discharge)</i>	6 to 8.5 hrs with PowerFlex charger																														
Temperature	Operating: 32 to 104 F (0 to 40 C) Storage: -4 to 113 F (-20 to 45 C) Charging: 50 to 113 F (10 to 45 C)																														
Humidity	0 to 95% non-condensing																														
Flow Fault	If the pump is unable to compensate for longer than 15 seconds due to excessive back pressure, the pump enters flow fault. During flow fault, the pump stops, the fault icon appears on the display, and elapsed time remains on the display. Auto-restart is attempted up to 5 times. Note: <i>Elapsed time information will be lost on restart.</i>																														
Low Battery Fault	LCD displays low battery icon and pump shuts down. LCD remains on.																														
Time Display	LCD shows elapsed pump run time in minutes up to 99,999. Note: <i>Older pump models display elapsed time up to three digits (999) and then roll back to zero.</i>																														
LCD Indicator	LCD always remains on. Displayed elapsed run time information resets when pump is started.																														
Noise Level	62.5 dBA* - pump without case 55 dBA* - pump housed in noise-reducing case (<i>optional accessory Cat. No. 224-96C, see Accessories</i>) * <i>Measured 3 ft (1 m) from pump operating at 2 L/min with a 37-mm, 0.8-μm MCE filter cassette</i>																														
RFI/EMI Shielding	27 to 1000 MHz																														
Intrinsic Safety	UL Listed for Intrinsic Safety: Class I, Division 1 and 2, Groups A, B, C, D; Class II, Division 1 and 2, Groups E, F, G; and, Class III, Temperature Code T3C. ATEX-approved models available. <i>Contact SKC.</i>																														
Dimensions	5 x 3 x 1.75 in (12.7 x 7.6 x 4.4 cm)																														
Weight	20 oz (567 grams)																														
Multiple-tube Sampling	<i>Requires additional accessories to sample with up to four sorbent tubes simultaneously at flows from 5 to 500 ml/min, dependent on back pressure. See Accessories.</i>																														
Tubing	<i>Requires 1/4-inch ID tubing</i>																														
Certifications	<ul style="list-style-type: none"> Intrinsic safety: UL Class I, Groups A, B, C, and D; Class II, Groups E, F, and G; Class III hazardous locations when used with SKC battery pack model P78011AMH (SKC Cat. No. P78011AMH) CE marked ATEX-approved models available 																														

Appendix (Cont)

Typical Run Times

Table 1 contains the typical run times achieved when using a fully charged NiMH battery pack. Data is sorted by type of sample media. All run times are listed in hours. Results are obtained using a new pump and new fully charged battery. Pump performance may vary. Increases in back pressure during sampling due to buildup of sample on the filter can decrease battery life.

Table 1. Pump Run Time in Hours with NiMH Battery

Mixed Cellulose (MCE) filter, 0.8- μ m pore size

Flow Rate (L/min)	Filter Diameter	
	37 mm	25 mm
2.0	40	37
2.5	38	29
3.0	34	25

Polyvinyl Chloride (PVC) filter, 5.0- μ m pore size

Flow Rate (L/min)	Filter Diameter	
	37 mm	25 mm
2.0	56	47
2.5	48	41
3.0	42	38