



# STABILITY FITOCLIMA WALK-IN STABILITY

TEMPERATURE AND HUMIDITY STABILITY STORAGE ROOMS  
ENVIRONMENTAL ROOMS FOR STABILITY STUDIES,  
SHELF-LIFE AND PACKAGE TESTING



ICH, GMP, WHO, FDA COMPLIANT





**ARALAB** is a company specialized in designing, developing, manufacturing and servicing of high quality climatic chambers and controlled environment rooms.

Since 1985 we have been perfecting ways to create and control temperature, humidity, light, air flow and many other environmental conditions.

Only the highest quality components are used to manufacture our chambers so customers can have the best equipment for their research and testing purposes.

**Control the environment, your own climate.**



**FitoClima Stability rooms provide the environmental control and storage flexibility to meet the evolving needs of customers throughout the years.**

**COMMON APPLICATIONS INCLUDE:**

- ICH STABILITY TESTING
- PHARMACEUTICALS
- FOOD AND BEVERAGES
- COSMETICS
- VETERINARY
- STORAGE AND CONSERVATION
- QUALITY CONTROL AND RESEARCH



Certified ISO:9001 for its Quality Management System













**KEY FEATURES**

- Environmental conditions controlled with consistent precision through the years
- Pre-configured with shelves designed to provide an efficient use of the internal volume
- Adaptive future proof design, with height adjustable trays and shelves that are easy to insert or remove depending on storage needs
- Content protection features, with configurable high / low temperature and humidity alarms and automatic remote notifications
- FDA 21 CFR part 11 compliant software
- Compliant and recognized by ICH, FDA, GMP and other leading industry standards
- IQ, OQ, PQ and ISO calibration documents

## TECHNICAL SPECIFICATIONS

### ● ● ● ● TECHNICAL DATA FOR FITOCLIMA 600 & 1200 STABILITY CHAMBERS

TEMPERATURE RANGE <sup>[1]</sup>		15°C to 45°C
TEMPERATURE PRECISION		± 0,5°C
TEMPERATURE UNIFORMITY		± 1,0°C
HUMIDITY RANGE <sup>[1]</sup>		35 to 90% rH
HUMIDITY PRECISION		± 1% RH
HUMIDITY UNIFORMITY		± 2% RH
STANDARD WIRE SHELF SIZE		630mm x 520mm
APPROXIMATE STORAGE CAPACITY <sup>[3]</sup> FitoClima 5.000 PH FitoClima 12.000 PH FitoClima 25.000 PH		10 m <sup>2</sup> 19,5 m <sup>2</sup> 32 m <sup>2</sup>
LIGHT		Recessed LED lights installed at the ceiling. Light can be operated by manual switch, triggered by door opening or controller integrated (programmable)
AIRFLOW VELOCITY		Can be adjusted by set-point % on the controller
INTERNAL VOLUMES <sup>[4]</sup>		Ranging from 5.000 to 25.000 liters

[1] Temperature range extension available from 5°C to 45°C. Please contact Aralab for other technical requirements

[2] Aralab Stability rooms are pre-configured with shelves to provide the most efficient use of the available space (5 levels with approximately 470mm or 530mm of depth each, depending on chamber model). Also available stainless steel AISI 304 shelves as option.

[3] Additional trays/levels can be added to shelving configuration.

[4] Other volumes available. Please consult Aralab for bespoke rooms and special requirements

### ● ● ● ● TEMPERATURE & HUMIDITY WORKING RANGE

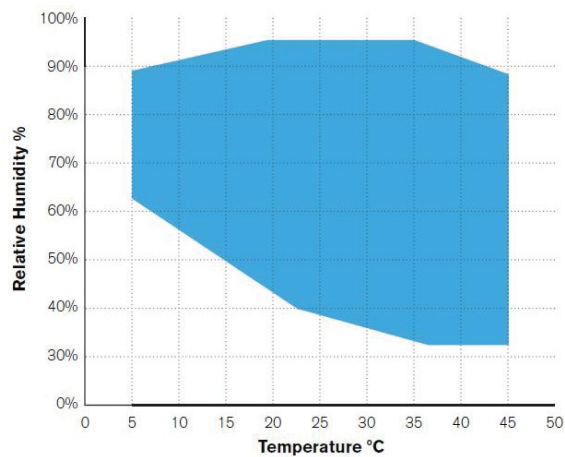

## DIMENSIONS AND DRAWINGS

### ● ● ● ● FITOCLIMA 5.000 PH

<b>EXTERNAL DIMENSIONS (HxWxD) (mm)</b>		2.610 x 2.225 x 2.715
<b>INTERNAL DIMENSIONS (HxWxD) (mm)</b>		2.040 x 2.010 x 1.610

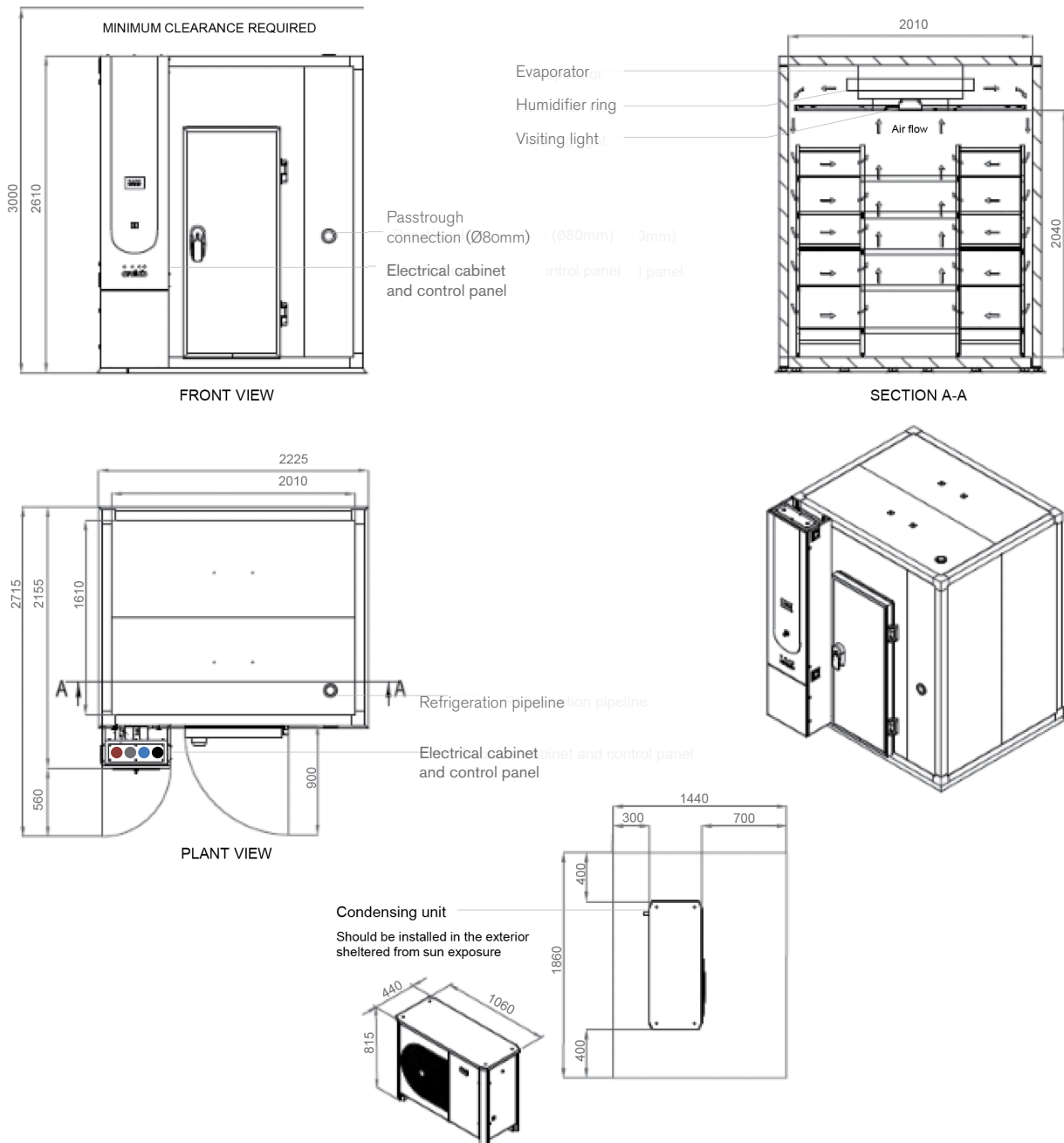

1. Standard refrigeration system is air cooled

2. Services installation needs:

- ½" demineralized water supply  
Conductivity: <math><40\mu\text{S}/\text{cm}</math>  
Pressure: 1-5 Bar
- 50mm water drain at floor level

3. Electrical cabinet installation needs:

- Supply power: 400VAC, 50Hz, 16A / 3-Phase + Neutral + Ground
- Electrical protection: Circuit breaker 3 x 16A + N with 300mA differential
- 3-Phase electrical cable RV-K 5G2.5 on the top
- RJ45 Ethernet socket communication port on the top

## DIMENSIONS AND DRAWINGS

### ● ● ● ● FITOCLIMA 12.000 PH

<b>EXTERNAL DIMENSIONS (HxWxD) (mm)</b>		2.610 x 2.225 x 4.320
<b>INTERNAL DIMENSIONS (HxWxD) (mm)</b>		2.040 x 2.010 x 3.210

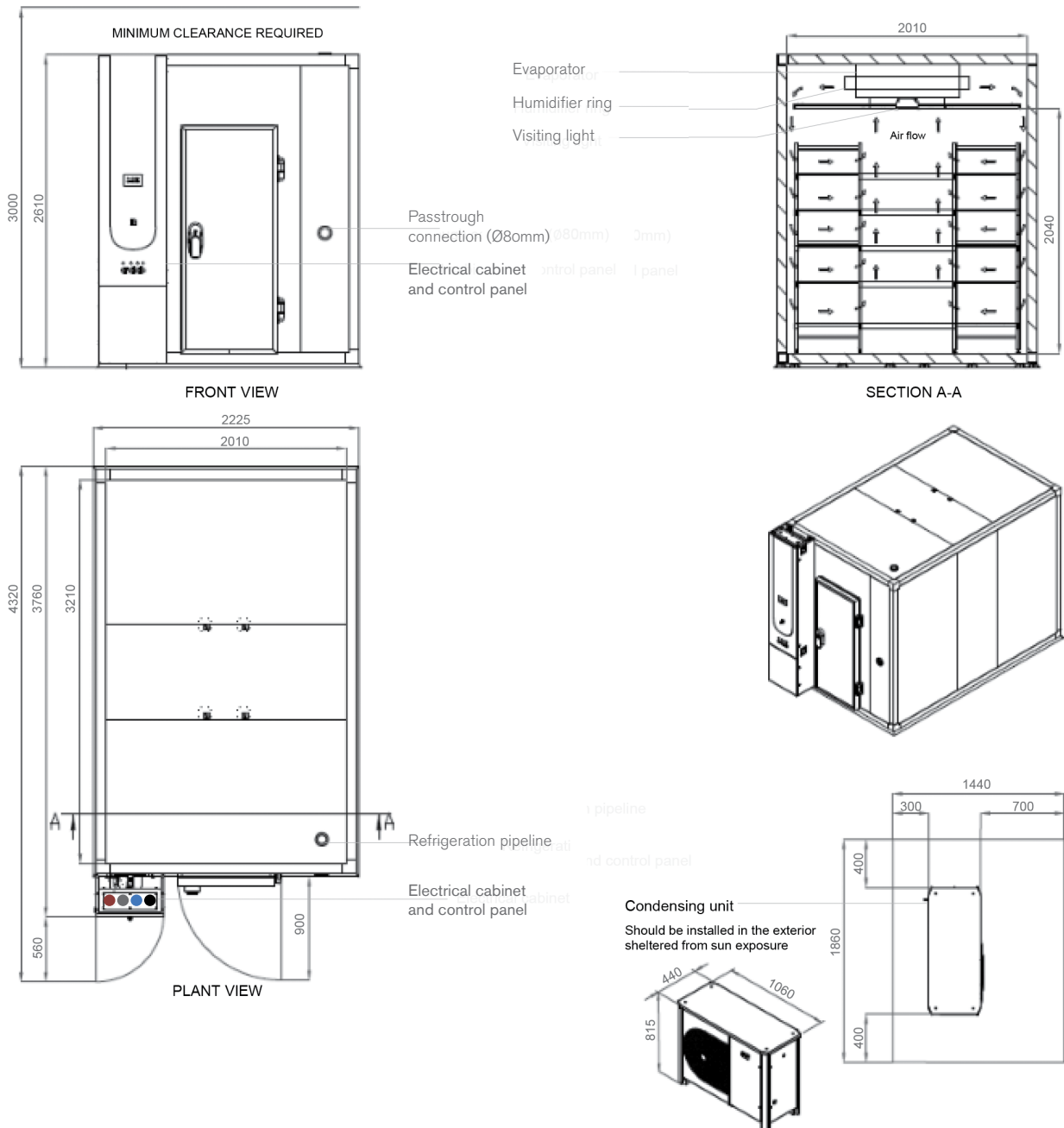

1. Standard refrigeration system is air cooled

2. Services installation needs:

- ½" demineralized water supply  
Conductivity: <math><40\mu\text{S}/\text{cm}</math>  
Pressure: 1-5 Bar
- 50mm water drain at floor level

3. Electrical cabinet installation needs:

- Supply power: 400VAC, 50Hz, 16A / 3-Phase + Neutral + Ground  
Electrical protection: Circuit breaker 3 x 16A + N with 300mA differential  
3-Phase electrical cable RV-K 5G2.5 on the top
- RJ45 Ethernet socket communication port on the top

## DIMENSIONS AND DRAWINGS

### FITOCLIMA 25.000 PH

<b>EXTERNAL DIMENSIONS (HxWxD) (mm)</b>		2.610 x 3.825 x 4.320
<b>INTERNAL DIMENSIONS (HxWxD) (mm)</b>		2.040 x 3.610 x 3.210



FRONT VIEW

Passthrough connection (Ø80mm)  
Electrical cabinet and control panel

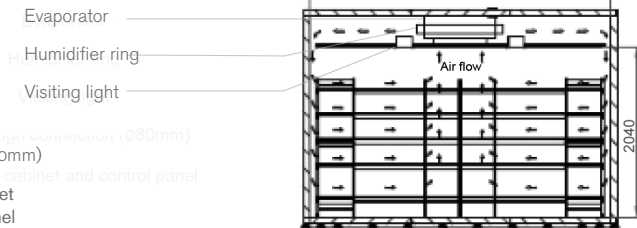

SECTION A-A

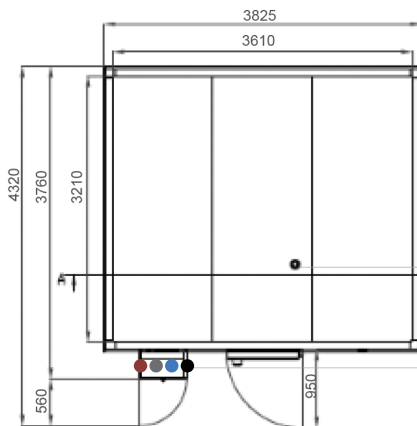



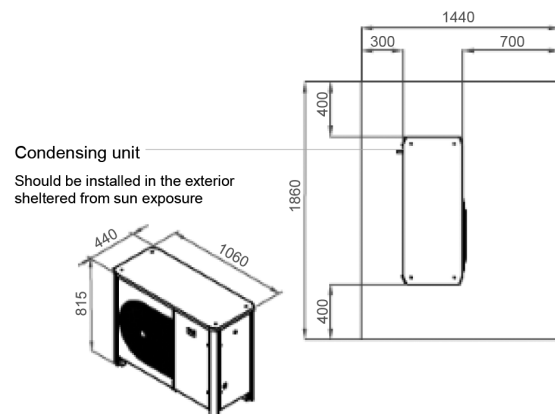
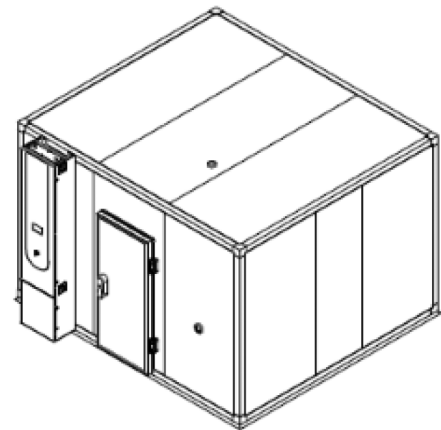

PLANT VIEW

Refrigeration pipeline

Electrical cabinet and control panel



- Standard refrigeration system is air cooled
- Services installation needs:
  -  ½" demineralized water supply  
Conductivity: <math><40\mu\text{S}/\text{cm}</math>  
Pressure: 1-5 Bar
  -  50mm water drain at floor level

- Electrical cabinet installation needs:
  -  Supply power: 400VAC, 50Hz, 16A / 3-Phase + Neutral + Ground  
Electrical protection: Circuit breaker 3 x 16A + N with 300mA differential  
3-Phase electrical cable RV-K 5G2.5 on the top
  -  RJ45 Ethernet socket communication port on the top

## EQUIPMENT DESCRIPTION



### CONSTRUCTION

- Exterior: EN 14509 sandwich type high density injected polyurethane foam modular panels, 80 mm thick (other thicknesses available for different specific insulation requirements) with galvanized steel in light gray plastic finish. CFC-free.
- Walls: Galvanized steel with white epoxy paint
- Shelving and trays: standard in anodized aluminium structures with polyethylene trays (5 tiers); optional in highly resistant stainless steel
- Floor: stainless steel slip resistant
- 80mm Ø entry-port
- New generation multi-color touch-screen ClimaPlus© controller
- Door with double gasket, key lock and safety opening mechanism from the inside
- Open door alarm with configurable time-out function
- Free slots for connecting and integrating external devices with the



### CLIMATIC CONTROL

- Air based, CFC free, mechanical refrigeration by hermetic condenser group
- Dual heating technology with hot gas by-pass and stainless steel electric heaters
- Humidification by ultrasonic generator with automatic water level control and self-cleaning function
- Also available with steam generator
- Dehumidification by condensation on the cooling system evaporator



### AIR FLOW

- Dynamic airflow with EC (variable) blower
- Forced in horizontal and downward direction
- Horizontal laminar airflow across the shelves to assure uniformity to all storage area
- Air renovation through adjustable lateral port-holes
- Airflow velocity adjustable at the ClimaPlus© controller

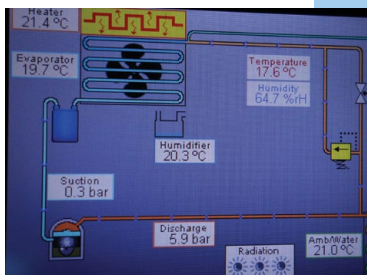

### CONTENT PROTECTION AND AUTOMATIC DIAGNOSTICS

- Independent thermostats for maximum and minimum temperature limits
- Automatic cut-off function, in case of excessive heating or cooling
- Configurable maximum and minimum temperature and humidity limits
- Visual and audible alarms for temperature and humidity limits
- Synoptic diagram function: a self-diagnostics tool that checks all active components of the system allowing for faster procedures and minimizing any possible downtimes

## CLIMAPLUS CONTROLLER

- Programmable Logic Controller exclusively developed by Aralab for FitoClima chambers
- Easy to use touch-screen interface
- 168mm x 112mm multicolor display
- Controls every environmental variable available for any specific FitoClima model (Temperature, Humidity, Lights, Airflow, CO<sub>2</sub>, O<sub>2</sub> and connected external devices)
- Friendly program editor for creating 32 programs of 24 segments each, allowing the design of complex and comprehensive climatic simulation programs
- Password protection of the controller functions
- Content and research protection feature, with configurable High and Low Temperature and Humidity alarms and automatic notifications
- Managing, monitoring and recording of all alarms
- Non-volatile memory, allowing the automatic restart of previously defined set-points or ongoing programs due to power failure, without losing data
- Real-time monitoring of all the functions and active components of the equipment, allowing for a fast and accurate diagnostic in case of malfunction
- Possibility to control and program events by external commands and with external devices
- Graphical view of programs and climatic variables
- RS232/485, Ethernet and Wi-Fi for connecting computers to the controller
- ClimaPlus controller functions also available at the PC/Laptop with the FitoLog software pack

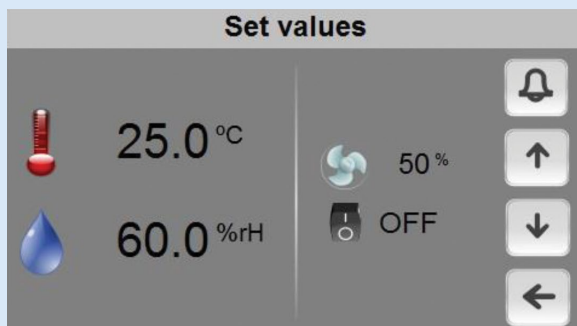
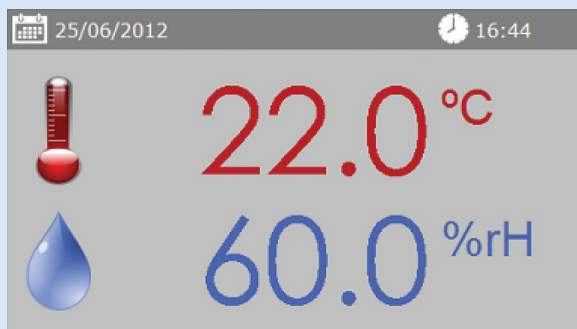



## FITOLOG SOFTWARE

The FitoLog software pack (FDA 21 CFR part 11 compliant) is a set of applications designed to facilitate the managing, monitoring and recording of programs and data from the FitoClima chambers. It consists of 3 applications: **FitoLog**, **FitoLogView** and **FitoProgram**.

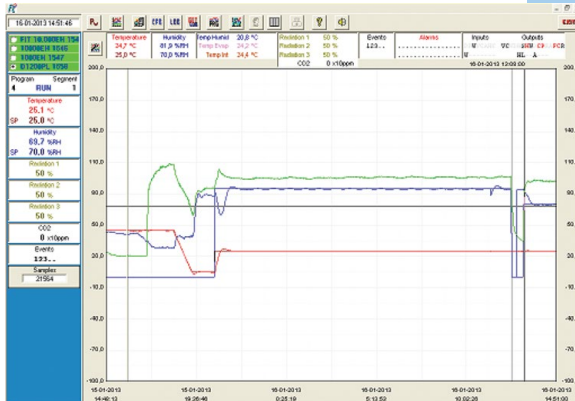

### FITOLOG

Records and displays in real time all data and details related to the set-points, running variables and equipment behaviour. It also retrieves information about the active components of the chamber, running processes, errors, alarms and allows the configuration of periodic or alarm triggered remote notifications (by email or SMS, depending on existing connections and accessories).

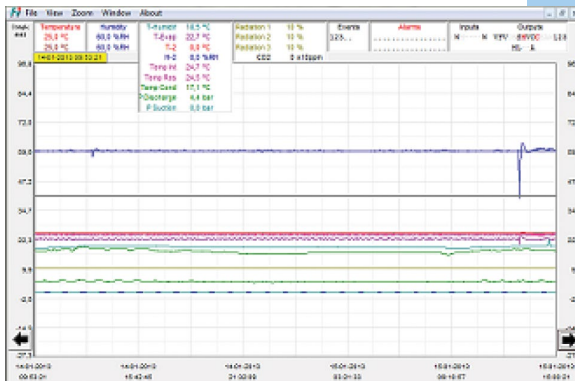

### FITOLOG

It is a working tool to process the data recorded by the FitoLog program. One can view, print and export the log contents to other file types, and analyse the data in other data management software (Excel, Star Office, Access or others).

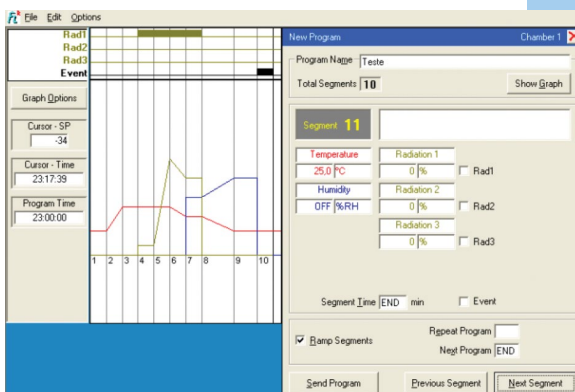

### FITOLOG

This application simplifies the creation of programs and its integration on the chamber ClimaPlus controller. Up to 32 programs, each with 24 segments, can be designed and linked to create detailed environmental profiles and simulations.

## CONTENT OF THE CHAMBER IS SECURED WITH ALARMS, NOTIFICATIONS, FAST DIAGNOSTICS AND PROMPT TROUBLESHOOTING

With FitoLog it is possible to gather data from each of the chambers systems, which makes it a very useful tool to diagnose any necessary maintenance. This tool works as the “black box” of the equipment, giving Aralab technicians the necessary data to remotely carry out a fast and efficient diagnostic. All that is needed is a FitoLog file.

## COMMON ACCESSORIES

### PLEASE CONSULT ARALAB FOR OTHER ITEMS

FitoLog® software pack for PC/Laptops, enabling data monitoring, logging (FDA 21 CFR part 11 compliant) and managing operations directly on a computer

IQ, OQ, PQ validations and documentation

ISO 17025 calibration

Additional temperature and humidity sensors

Additional shelves and racks

Shelves in AISI 304 stainless steel

Observation window on the door

Ethernet / Wi-Fi / Other connections for computer connection

Additional entry port

Extended temperature ranges

Integrated water tank with electric pump and security valve

Wall mounting conductivity meter, for water quality control, with assembling accessories

5 stage Reverse Osmosis with pre-decalcification water treatment system

Internal electrical connection sockets

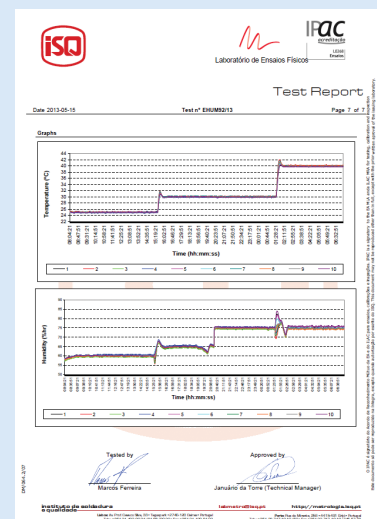
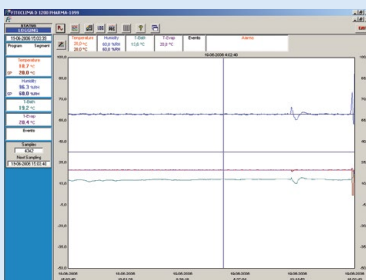

## ARALAB STABILITY - CUSTOMER APPLICATIONS

CUSTOMER SPECIFICATIONS AND ACCESSORIES MAY RESULT IN DIFFERENT PRODUCT IMAGES)



ARALAB FITOCLIMA 25.000 PH  
PHARMACEUTICAL PRODUCTS LONG TERM



STAINLESS STEEL SHELVING WITH 9 RACKS  
FOR MAXIMUM STORAGE CAPACITY



STABILITY ROOMS TURNKEY PROJECT BY ARALAB

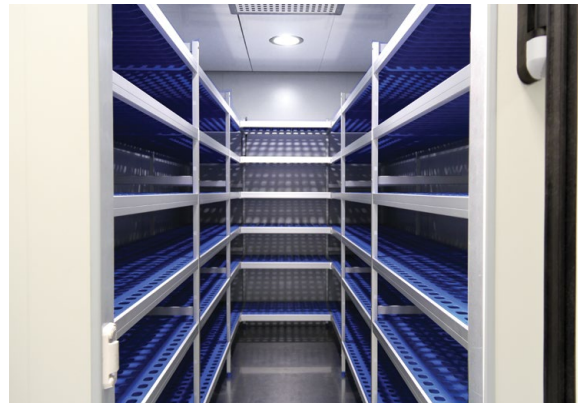

SIX TIER SHELVING IN ANODIZED ALUMINIUM  
WITH POLYETHYLENE TRAYS



SET OF 8 X FITOCLIMA STABILITY ROOMS  
AT A STABILITY SERVICES COMPANY



INTERIOR OF FITOCLIMA 12.000PH RUNNING  
AT 30°C / 75%RH

Features and specifications are subject to change. Aralab continuously studies ways to further develop its products to achieve better performances and overall product quality. As a result, characteristics and specifications provided in this document may be subject to changes.

Let's meet!  
aralab@aralab.pt  
www.aralab.pt  
T: +351 219 154 960



**Control the environment**  
Your own climate

