

Pressure Transmitter - ATEX certified

## ATM/Ex - Analog Pressure Transmitter



### CUSTOMER BENEFITS

- Certificate: ATEX & EAC
- Fast customization thanks to configurable product design
- Demountable electrical connector option allow adjustment of zero and span setting in the field
- Compact design requires minimal space
- Short response times suitable for dynamic pressure measurements

# Accessories

---

## CABLE SOCKET CONNECTOR

HART001	Cable Socket Connector DIN 43650
HART002	Cable socket M16, Binder 723, IP67, 5-pins
HART006	RSF50, IP67, 2m, angled, for absolute and sealed gauge
HART009	M16 (Binder 723), IP 67, 12 -pins
HART012	MIL C26482, 10-6, IP40, 6- pins
HART018	M12 (Lumberg RSF 4/5), 5- pins
HART026	M16 (Binder 723), IP67, 7- pins
HART049	Cable socket connector RSF50
HART058	Cable socket connector, DIN 43650, micro

## OVERVIEW

10.00.0091	Accessories overview

# Technical Specifications

---

## PRESSURE MEASURING RANGE (BAR)

	0.1 ... 0.5, (1)	> 0.5 ... 2	> 2 ... 25
Overpressure	3 bar	3 x FS ( $\geq 3$ bar)	3 x FS
Burst pressure, (5)	> 200 bar	> 200 bar	> 200 bar
Accuracy, (6) ( $\pm$ % FS)	$\leq 0.5 / \leq 0.25$	$\leq 0.5 / \leq 0.25 / \leq 0.1$	$\leq 0.5 / \leq 0.25 / \leq 0.1$
Thermal shift, ( $\pm$ % FS/ $^{\circ}$ C)			
Zero point 0 ... 70 $^{\circ}$ C	$\leq 0.06$	$\leq 0.03$	$\leq 0.015$
Zero point -25 ... 85 $^{\circ}$ C	$\leq 0.08$	$\leq 0.04$	$\leq 0.02$
Span 0 ... 70 $^{\circ}$ C	$\leq 0.015$	$\leq 0.015$	$\leq 0.015$
Span -25 ... 85 $^{\circ}$ C	$\leq 0.02$	$\leq 0.02$	$\leq 0.02$
Response time (typ.)	< 1ms/10 ... 90%	< 1ms / 10 ... 90% FS	< 1ms / 10 ... 90% FS
Long term stability, (7)	< 0.5% FS / < 4 mbar	< 0.2% FS / < 4 mbar	< 0.1% FS / < 0.2% FS

	> 25 ... 600, (2), (3), (4)	> 600 ... 1000, (2), (8)
Overpressure	3 x FS ( $\leq 850 / \leq 1500$ bar)	1500 bar
Burst pressure, (5)	> 850 / $\leq 1500$ bar	> 1500 bar
Accuracy, (6) ( $\pm$ % FS)	$\leq 0.5 / \leq 0.25 / \leq 0.1$	$\leq 1 / \leq 0.5 / \leq 0.25$
Thermal shift, ( $\pm$ % FS/ $^{\circ}$ C)		
Zero point 0 ... 70 $^{\circ}$ C	$\leq 0.015$	$\leq 0.015$
Zero point -25 ... 85 $^{\circ}$ C	$\leq 0.02$	$\leq 0.02$
Span 0 ... 70 $^{\circ}$ C	$\leq 0.015$	$\leq 0.015$
Span -25 ... 85 $^{\circ}$ C	$\leq 0.02$	$\leq 0.02$
Response time (typ.)	< 1ms / 10 ... 90% FS	< 1ms / 10 ... 90% FS
Long term stability, (7)	< 0.1% FS / < 0.2% FS	< 0.1% FS / < 0.2% FS

(1) 50 mbar on request

(2) Titanium available  $\leq 400$  bar (burst pressure > 550 bar)

(3) Process connection frontal and flush diaphragm available  $\leq 600$  bar

(4) Overpressure and burst pressure 1500 bar (stainless steel) optional

(5) Transducer

(6) Zero based accuracy according to DIN-16086, incl. hysteresis and repeatability at ambient temperature

(7) 1 year (typ. / max.), the long term stability can be improved by ageing (burn-in) the sensor

(8) Maximum pressure allowed by FM/FMc certification body 690bar

## TEMPERATURE RANGE

Operating temperature	-25 ... 85 $^{\circ}$ C
Process temperatur	-40 ... 150 $^{\circ}$ C
Storage temperatur	-25 ... 85 $^{\circ}$ C

## ELECTRICAL SPECIFICATIONS

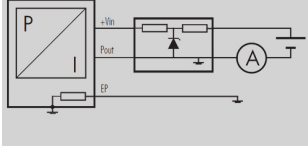
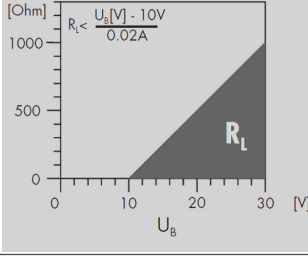
	4 ... 20 mA
Power supply	10 ... 30 VDC
Supply influence	< 0.1% FS
Circuit diagram	
Load resistance	
Load influence	< 0.1% FS

## ATEX APPROVAL

Certificate, (1)	SEV 11 ATEX 0142		
Gas	II 1G Ex ia IIC T3 ... T6	EN 60079-0 / -11 / -26	
Dust	II 1D Ex iaD 20 IP6x T125°C ... T80°C		
Mining	I M1 Ex ia I	EN 50303	
Temperature class, (2)	T6	T4	T3
Ambient temperature	-25 ... 55°C	-25 ... 85°C	-25 ... 85°C
Process temperature	-25 ... 55°C	-25 ... 100°C	-25 ... 150°C
Maximum values of the connection circuit	30 V / 100 mA / 1 W		

(1) For detailed Ex specifications see certificate and operating and safety instructions

(2) Without any information about temperature class the transmitter will be delivered for T4

## GL APPROVAL

Certificate	40868-01 HH
Field of application	C, EMC1

## QUALIFICATIONS

	Description	Level	Typical interferences
EN 61000-4-2	Electrostatic discharge	8 kV contact / 15 kV air	
EN 61000-4-3	Irradiated RF	10V/m (0.08 ... 2.7 GHz, 3s)	Radio sets, wireless phones
EN 61000-4-4	Transients (burst)	2 kV	Motors, valves
EN 61000-4-5, (1)	Surge	10 kA (8 / 20 µs), (1)	Overvoltage
EN 61000-4-6	Conducted RF	10 V (0.15 ... 80 MHz, 3 s)	Frequency converters

(1) Only with optional surge (lightning) protection

## PHYSICAL SPECIFICATIONS

Materials	
Transducer	Stainless steel (316L / 1.4435), titanium (Gr. 2), (1)
Housing	Stainless steel (316L / 1.4404), titanium (Gr. 2)
Seals	Viton (Standard), EPDM, Kalrez
Cable	PUR, FEP

(1) Hastelloy (C-276) on request

## Additional documents

---

## OPERATING AND SAFETY INSTRUCTIONS

Article number	
10.88.0437	DMM042

# Ordering information

	X.	XXXX.	XXXX.	XX.	XXX
<b>Type</b>					
	ATM/Ex	33			
<b>Pressure type</b>					
	Gauge	1			
	Absolute (vacuum)	2			
	Sealed gauge	3			
<b>Pressure measuring range</b>					
	100 mbar ... 600 bar		XX		
	> 600 bar		XX		
	Negative ranges, offset, special adjustment	99			
<b>Process connection</b>					
	G 1/4 F (Fig. 1)		00		
	1/4 NPT M		10		
	1/2 NPT M (Fig. 8)		19		
	G 1/4 M (Fig. 2)		11		
	G 1/4 flush diaphragm, (4)		21		
	G 1/4 M, manometer DIN 16288 (Fig. 3)		12		
	G 1/2 M (Fig. 4)		13		
	G 1/2 M, Hastelloy C-276		98		
	G 1/2 M, frontal diaphragm (Fig. 5), (4)		14		
	G 1/2 male, frontal diaphragm Hastelloy C-276, (4)		37		
	G 1/2 M, flush diaphragm (Fig. 6), (4)		15		
	G 1/2 M, manometer DIN-16288 (Fig. 7)		16		
	G 1/2 male with bore Ø 14 mm		17		
	Customized		99		
<b>Electrical connection</b>					
	DIN-43650 with metal threaded part, demountable, IP 65 (Fig. 10), (5), (16)		01		
	M16 (Binder 723), 5 pins, IP 67 (Fig. 11), (5)		03		
	M16 (Binder 723), 5 pins, demountable, IP 67, (Fig. 12), (5)		43		
	MIL C26482, 10-6, IP 40 (Fig. 13), (5)		06		
	M12x1, 4 pins (Fig. 15), (5)		07		
	PUR cable, blue, IP 67 (Fig. 14), (6), (7)		17		
	PUR cable, blue, with submersible back end IP 68		36		
	FEP cable, blue, IP 67 (Fig. 14), (6)		22		
	Customized		99		
<b>Output signal</b>					
	4 ... 20 mA			05	
	4 ... 20 mA with surge protection			08	
<b>Accuracy</b>					
	≤ 600 bar ≤ ± 0.5 % FS				0
	≤ 600 bar ≤ ± 0.25 % FS				1
	≤ 600 bar ≤ ± 0.1 % FS				2
	> 600 bar ≤ ± 1 % FS				5
	> 600 bar ≤ ± 0.5 % FS				0
	> 600 bar ≤ ± 0.25 % FS				1

<b>Temperature range</b>				
	T6 (Ta: -25 ... 55°C) 0 ... 70°C compensated (allowed process temperature: -25 ... 55°C)			0
	T4 (Ta: -25 ... 85°C) -25 ... 85°C compensated (allowed process temperature: -25 ... 100°C)			1
	T3 (Ta: -25 ... 85°C) -25 ... 85°C compensated (allowed process temperature: -25 ... 150°C)			2
<b>Option 1</b>				
	Throttle, (8)			A
	Special oil filling: Anderol Food (for food applications)			G
	Special oil filling: AS100			J
	Special oil filling: PAO4 (silicone free)			Q
	Pressure connection elastomerfree			N
	Pressure connection welded			V
<b>Option 2</b>				
<b>Option 3</b>				
	Version titanium			K
	Seals: Viton (standard)			U
	Seals: EPDM			S
	Seals: Kalrez (Industry)			T

(4) Process connection available ≤ 600 bar

(5) Cable socket connector not included

(6) Please specify the required cable length and medium

(7) For operating temperature > 50°C, FEP cable must be used

(8) Only with pressure connection Fig. 2, Fig. 3, Fig. 4, Fig. 7 and Fig. 8

(16) Connector side not to be used in Zone 0 or Ex ia IIC, explosion risk

**Pressure connections**

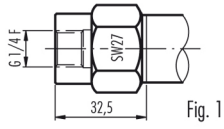

Fig. 1

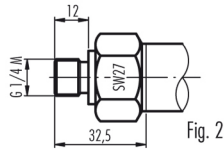

Fig. 2

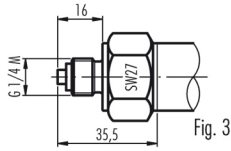

Fig. 3

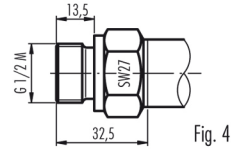

Fig. 4

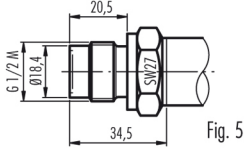

Fig. 5

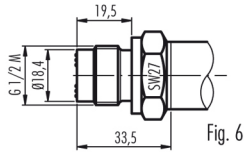

Fig. 6

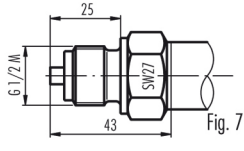

Fig. 7

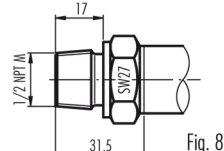
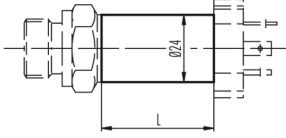

Fig. 8

**Dimensions**

Version for temperature class T4...T6



L = 55mm for connector DIN 43650 (Fig. 10)  
L = 94mm for version with surge (lightning) protection

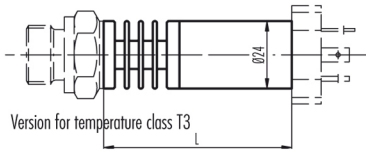

Version for temperature class T3

L = 82mm for connector DIN 43650 (Fig. 10)  
L = 121mm for version with surge (lightning) protection

**Electrical connections**

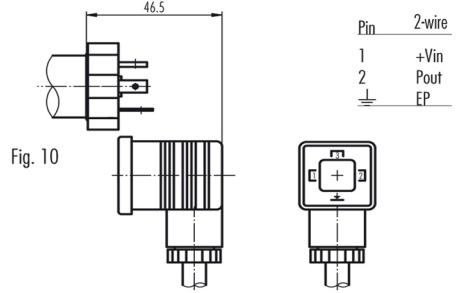

Fig. 10

Pin	2-wire
1	+Vin
2	Pout
⊥	EP

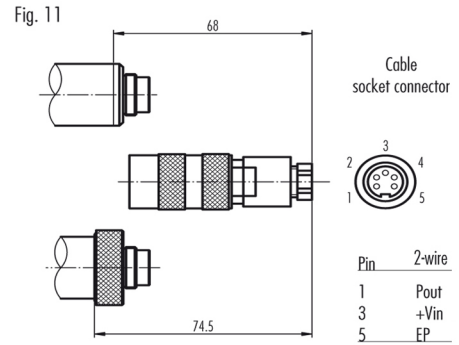

Fig. 11

Cable socket connector

Pin	2-wire
1	Pout
3	+Vin
5	EP

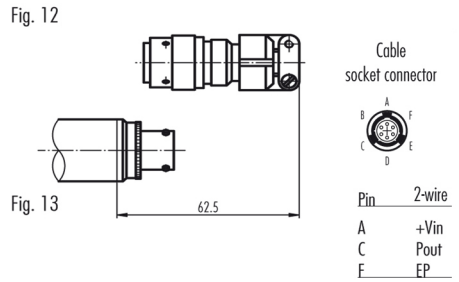

Fig. 12

Cable socket connector

Pin	2-wire
A	+Vin
C	Pout
F	EP

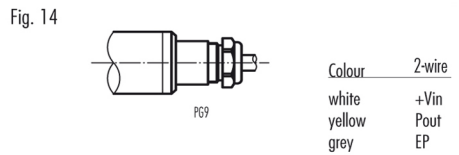

Fig. 14

Colour 2-wire

white	+Vin
yellow	Pout
grey	EP

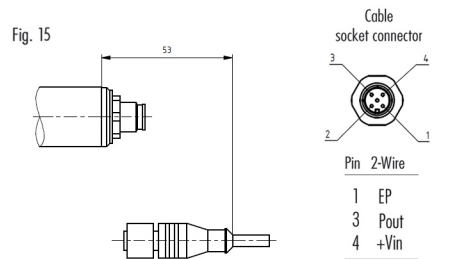

Fig. 15

Cable socket connector

Pin	2-Wire
1	EP
3	Pout
4	+Vin