



Infrared thermometers

Infrared video thermometers

Infrared cameras

Portable thermometers

PRODUCT OVERVIEW

Non-contact temperature measurement

Made in Germany

innovative infrared technology

The adequate measurement device

Spot measurement or thermal image?

First of all, it is important to define the measurement task and to decide on one of these two measures:



A **point measuring infrared thermometer** should be used if you know where the critical point or the area to be measured is positioned within your application. The size of the measuring object is important to define which lens is necessary. It is therefore possible to monitor the accurate temperature and optimize processes – if necessary – before quality problems arise.

Pyrometer configurator:
www.optris.com/pyrometer-selector

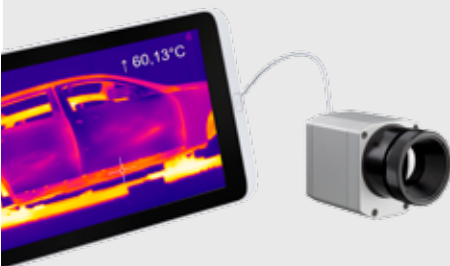

Infrared cameras should be used in cases where more than one critical area exists or the area cannot be clearly defined. Critical areas can be localized by the camera through the demonstration of thermal images. The areas can then be permanently monitored by one or multiple fixed infrared thermometers.

Which object surface?

The condition of the object surface defines the measurement device and wavelength to be used for the application. The **emissivity ϵ** occupies a central position. The choice of the right device is of great importance especially for metals, where the emissivity depends on the temperature and wave length.

We are able to offer appropriate measurement devices for most applications throughout a wide product range.

The following explanation helps to find the right **wavelength** for your application:

- 8 – 14 μm for non-metal surfaces (Type of device: LT)
- 0.5; 1.0; 1.6; 2.3 μm mainly for liquid metals and metal surfaces (Type of device: 05M; 1M; 2M; 3M)
- 3.43 μm for thin plastic films like PE, PP and PS (Type of device: P3)
- 3.9; 4.24; 4.64; 7.9 μm for special applications (Type of device: MT; F2; F6)
- 5.0 μm for glass surfaces (Type of device: G5)
- 7.9 μm for plastic foils and glass surfaces (Type of device: P7/G7)

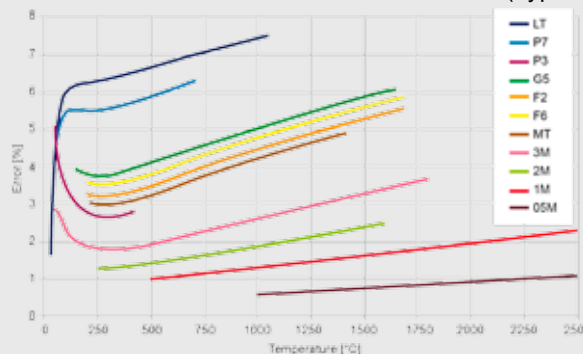

Short wavelengths reduce measurement errors on surfaces with low, unknown or changing emissivity. This occurs mostly with metals. The diagram above shows the measurement errors across different wavelengths if the emissivity is wrongly adjusted by only 10 percent.

Which temperature range?

The temperature is another factor to decide on. The range should cover all relevant temperatures of the

application. The measurement range of the devices is between **-50 °C and 3000 °C**.

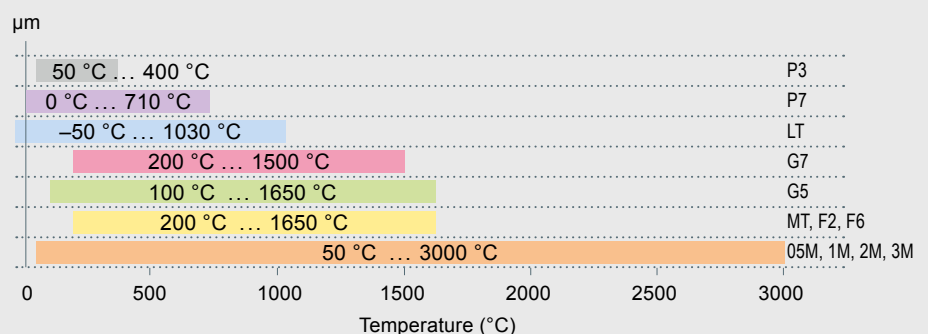

Display of temperature over wavelength for the devices of the compact and the high performance series

Which process velocity?

To achieve accurate temperature measurement it is important to know how fast measuring objects are moving in front of the sensor or how fast they change temperature.

Our fastest infrared thermometer captures changes within **1 ms**.



Display of fast temperature changes over a period of time.

Integration of sensors?

Our temperature sensors can be installed as part of the process with **mounting brackets** or **flanges**.

Depending on the device, we offer different analog and digital interfaces for **data evaluation** such as triggering, alerting or saving of data.

Analog Interfaces:

0 – 20 mA, 4 – 20 mA, 0 – 5 V, 0 – 10 V,
Thermocouple (type J, type K)

Digital Interfaces:

USB, RS232, RS485, Relay, Profibus DP, CAN Bus, Ethernet

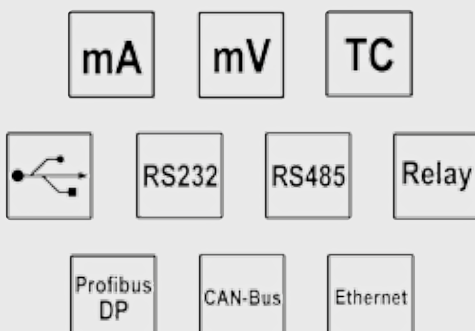

Object size and measurement distance

IR thermometers use the radiation signal emitted by the entire measurement spot. The size of the measurement spot (S) largely depends on the device, the optics selected and the distance between the sensor and measurement object plane (D):

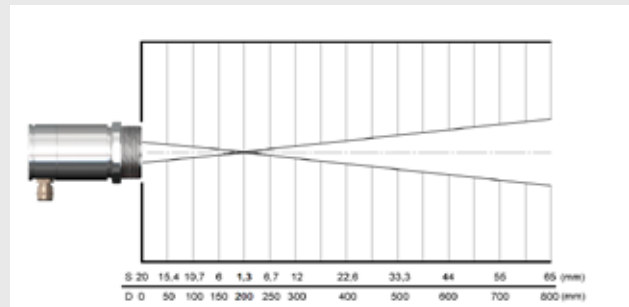

Measurement spot diameter (S) depending on the measurement distance (D) with an IR thermometer

For a precise temperature measurement, the measurement spot needs to be smaller than, or the same size as the object to be measured.

If the measurement spot is larger than the object, a temperature is calculated from the averaged heat radiation signal from the object and its environment. In a colder environment, it means that correspondingly, the temperature measurement value determined is too low.

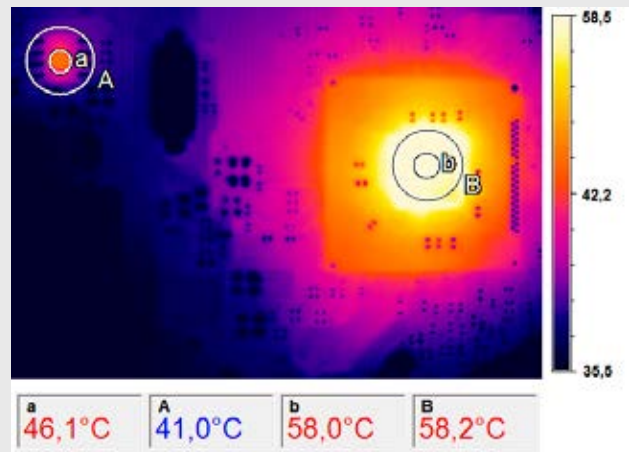

IR image of an electronics circuit board – adaptation of the measurement spot to the object size

When transferred to the two-dimensional measurement with IR cameras, the pixel size there needs to suit the object size for the selected measurement distance. Here, the object should fill at least 3x3 pixels.

In the example above, the correct temperature of a chip of 46 °C is determined with the suitable measurement spot size (a). A measurement spot (A) which is three times larger already leads to a measurement error of 5 °C or 10%. If you select a larger component on the same circuit board (on the right in the picture), then in this case, both measurement spots (b and B) provide the correct temperature measurement value of 58 °C.

Compact series

Small, compact infrared thermometers, ideal for use in cramped and hot surroundings



Base Model	CS	CSmicro	CSmicro 2W	CSmicro 2W	CSmicro 2W
Type	LT	LT02 / LT15 / 3M	LT15/LT15H/LT22H	hs LT	2M
Classification / special features	Single-piece sensor with smart LED display (self diagnostics, aiming support, alarm, temperature code)	Single-piece sensor with electronics in cable and smart LED display (aiming support, alarm, temperature code)	Single-piece two-wire sensor with electronics in cable; smart LED display (aiming support, alarm, temperature code)	Single-piece two-wire sensor with electronics in cable with high thermal sensitivity; smart LED display; temperature code	Single-piece two-wire sensor with electronics in applications; smart LED display; temperature code
Detector	Thermopile	Thermopile/3M: Ext. InGaAs	Thermopile	Thermopile	InGaAs
Sensing head exchangeable	-	-	-	-	-
Head cable shortening	■	■ (behind electronics)	■ (behind electronics)	■ (behind electronics)	■ (behind electronics)
Thread (sensing head)	M12x1	M12x1	M12x1	M18x1	M12x1
Spectral range	8–14 μm	8–14 μm / 3M: 2.3 μm	8–14 μm	8–14 μm	1.6 μm
Temperature ranges	-40 °C ... 1030 °C	-40 °C ... 1030 °C 3ML: 50 °C ... 350 °C 3MH: 100 °C ... 600 °C	-40 °C ... 1030 °C	-20 °C ... 150 °C	2ML: 250 °C ... 800 °C 2MH: 385 °C ... 1600 °C
Temperature resolution	0.1 K	0.1 K	0.1 K	0.025 K [>20 °C]	0.1 K
Optical resolution	15:1	LT02: 2:1 / LT15: 15:1 / 3ML: 22:1 / 3MH: 33:1	LT15: 15:1 / LT15H: 15:1 / LT22H: 22:1	15:1	2ML: 40:1 2MH: 75:1
Option: CF lens	■	■	■	■	■
Smallest spot (CF optics/add. CF lens)	0.8 mm @ 10 mm	LT02: 2.5 mm @ 23 mm LT15: 0.8 mm @ 10 mm 3M: 1.5 mm @ 10 mm	LT15: 0.8 mm @ 10 mm LT15H: 0.8 mm @ 10 mm LT22H: 0.6 mm @ 10 mm	0.8 mm @ 10 mm	2MH: 1.5 mm @ 110 mm 2ML: 2.7 mm @ 110 mm
Smallest spot (SF optics)	7 mm	7 mm	7 mm	7 mm	7 mm
Sighting	LED aiming	LED aiming	LED aiming	LED aiming	LED aiming
Response time (90 %)	25 ms	25 ms	LT: 25 ms / LTH: 150 ms	150 ms	10 ms
Accuracy	±1.5 °C or ±1.5 %	±1 °C or ±1 %	±1 °C or ±1 %	±1 °C or ±1 %	±(0.3 % T _{meas} + 2 °C)
Outputs analog: 0–20 mA / 4–20 mA / 0–5 V / 0–10 V / t/c (K/J)	- / - / ■ / ■ / ■	- / - / ■ / ■ / -	- / ■ / - / - / -	- / ■ / - / - / -	- / ■ / - / - / -
Second analog output	-	-	-	-	-
Interfaces: USB / RS232 / RS485 / Profibus / Ethernet	■ / - / - / - / -	■ / - / - / - / -	■ / - / - / - / -	■ / - / - / - / -	■ / - / - / - / -
Signal processing: Peak / Valley / AVG / Advanced hold	■ / ■ / ■ / ■	■ / ■ / ■ / ■	■ / ■ / ■ / ■	■ / ■ / ■ / ■	■ / ■ / ■ / ■
T _{Amb} Head min.	-20 °C	-20 °C	-20 °C	-20 °C	-20 °C
T _{Amb} Head max.	80 °C	LT02/LT15: 120 °C 3M: 85 °C	LT15: 120 °C LT15H/LT22H: 180 °C	75 °C	125 °C
T _{Amb} Electronics max.	80 °C	80 °C	75 °C	75 °C	75 °C
Functional inputs/ number	■ / 1	■ / 1	- / -	- / -	- / -
External emissivity adjustment	■ (via V _{cc} adjust)	■ (via V _{cc} adjust)	-	-	-
External background temperature control	■	■	-	-	-
Trigger input for reset of hold functions	■	■	-	-	-
Digital I/O pins/ number	-	-	-	-	-
Simultaneous analog and digital output	-	-	■	■	■
Alarm output as an alternative to analog output	■	■	■	■	■
Additional alarm output/ switching output	■	■	■	■	■
Voltage supply	5–30 V DC	5–30 V DC	5–30 V DC	5–30 V DC	5–30 V DC
Standard cable length	1 m	1 m	1 m	4 m	1 m
Cable length options	3 / 8 / 15 m	Options up to 9 m	Options up to 9 m	-	Options up to 9 m

Spot size calculator:
www.optris.com/spot-size-calculator

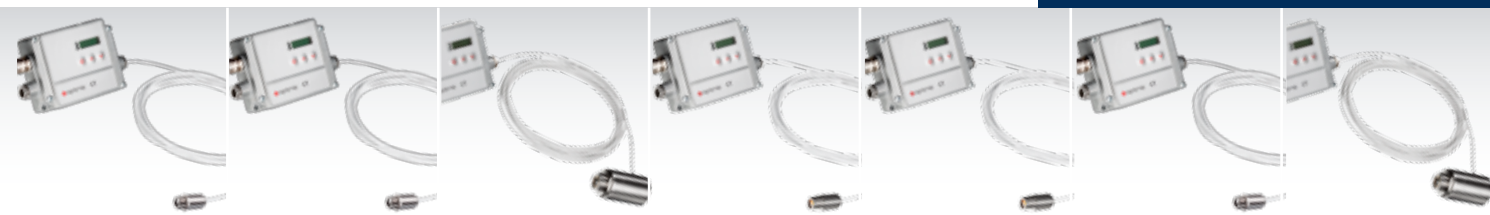

CT	CTfast	CThot	CT	CT	CT	CT
LT02 / LT15 / LT22	LT15F / LT25F	LT02H / LT10H	1M / 2M	3M	G5	P3 / P7
Two-piece sensor with separate electronic box incl. programming keys and display	Two-piece sensor with fast response time and separate electronic box incl. programming keys and display	Two-piece sensor for hot surroundings with separate electronic box incl. programming keys and display	Two-piece sensor for high temp. meas. of metal with separate electronic box incl. progr. keys and display	Two-piece sensor for low temp. meas. of metal with separate electronic box incl. progr. keys and display	Two-piece sensor for temp. meas. of glass with separate electronic box incl. progr. keys and display	Two-piece sensor for temp. meas. on thin plastic film and glass (P7) with separate electronic box incl. progr. keys and display
Thermopile	Thermopile	Thermopile	1M: Si / 2M: InGaAs	Extended InGaAs	Thermopile	Thermopile (P7)
■	-	■	■	■	■	-
■ [-0.1 K/m]	■ [max. 3 m]	■ [-0.1 K/m]	■ [max. 3 m]	■	■ [-0.1 K/m]	-
M12x1	M12x1	M18x1	M12x1	M12x1	M12x1	M18x1
8-14 µm	8-14 µm	8-14 µm	1M: 1.0 µm / 2M: 1.6 µm	2.3 µm	5.0 µm	P3: 3.43 µm / P7: 7.9 µm
LT02: -50 °C ... 600 °C LT15: -50 °C ... 600 °C LT22: -50 °C ... 975 °C	-50 °C ... 975 °C	-40 °C ... 975 °C	1ML: 485 °C ... 1050 °C 1MH: 650 °C ... 1800 °C 1MH1: 800 °C ... 2200 °C 2ML: 250 °C ... 800 °C 2MH: 385 °C ... 1600 °C 2MH1: 490 °C ... 2000 °C	L: 50 °C ... 400 °C H: 100 °C ... 600 °C H1: 150 °C ... 1000 °C H2: 200 °C ... 1500 °C H3: 250 °C ... 1800 °C	L: 100 °C ... 1200 °C H: 250 °C ... 1650 °C	P3: 50 °C ... 400 °C P7: 0 °C ... 710 °C
0.1 K	LT15F: 0.2 K LT25F: 0.4 K	0.25 K	0.1 K	0.1 K	L: 0.1 K H: 0.2 K	P3: 0.1 K / P7: 0.5 K
LT02: 2:1 / LT15: 15:1 / LT22: 22:1	LT15F: 15:1 LT25F: 25:1	LT02H: 2:1 LT10H: 10:1	L: 40:1 H: 75:1	L: 22:1 / H: 33:1 / H1-H3: 75:1	L: 10:1 H: 20:1	P3: 15:1 P7: 10:1
■	■	■	■	■	-	-
LT02: 2.5 mm @ 23 mm LT15: 0.8 mm @ 10 mm LT22: 0.6 mm @ 10 mm	0.5 mm @ 10 mm	LT02H: 2.5 mm @ 23 mm LT10H: 1.2 mm @ 10 mm	1.5 mm @ 110 mm	3.4 mm @ 110 mm	-	P7: 1.2 mm @ 10 mm
7 mm	7 mm	7 mm	7 mm	7 mm	7 mm	7 mm
-	-	-	-	-	-	-
150 ms	LT15F: 9 ms / LT25F: 6 ms	100 ms	1 ms	1 ms	L: 120 ms / H: 80 ms	P3: 100 ms / P7: 150 ms
±1 °C or ±1 %	±2 °C or ±1 %	±1.5 °C or ±1 %	±(0.3% T _{meas} + 2 °C)	±(0.3% T _{meas} + 2 °C)	±2 °C or ±1 %	P3: ±3 °C or 1 % P7: ±1.5 °C or 1 %
■ / ■ / ■ / ■ / ■	■ / ■ / ■ / ■ / ■	■ / ■ / ■ / ■ / ■	■ / ■ / ■ / ■ / ■	■ / ■ / ■ / ■ / ■	■ / ■ / ■ / ■ / ■	■ / ■ / ■ / ■ / ■
■	■	■	-	-	■	■
■ / ■ / ■ / ■ / ■	■ / ■ / ■ / ■ / ■	■ / ■ / ■ / ■ / ■	■ / ■ / ■ / ■ / ■	■ / ■ / ■ / ■ / ■	■ / ■ / ■ / ■ / ■	■ / ■ / ■ / ■ / ■
■ / ■ / ■ / ■	■ / ■ / ■ / ■	■ / ■ / ■ / ■	■ / ■ / ■ / ■	■ / ■ / ■ / ■	■ / ■ / ■ / ■	■ / ■ / ■ / ■
-20 °C	-20 °C	-20 °C	-20 °C	-20 °C	-20 °C	P3: 0 °C / P7: -20 °C
LT02: 130 °C LT15/LT22: 180 °C	120 °C	250 °C	1M: 100 °C 2M: 125 °C	85 °C	85 °C	P3: 75 °C / P7: 85 °C
85 °C	85 °C	85 °C	85 °C	85 °C	85 °C	P3: 75 °C / P7: 85 °C
■ / 3	■ / 3	■ / 3	■ / 3	■ / 3	■ / 3	■ / 3
■	■	■	■	■	■	■
■	■	■	■	■	■	■
■	■	■	■	■	■	■
-	-	-	-	-	-	-
■	■	■	■	■	■	■
■	■	■	■	■	■	■
■	■	■	■	■	■	■
8-36 V DC	8-36 V DC	8-36 V DC	8-36 V DC	8-36 V DC	8-36 V DC	8-36 V DC
1 m	1 m	3 m	3 m	3 m	3 m	3 m
3 / 8 / 15 m	3 / 8 / 15 m	8 / 15 m	8 / 15 m	-	8 / 15 m	P3: 8 m / P7: 8 m, 15 m

High performance series

Infrared thermometers with highest optical resolution and double laser

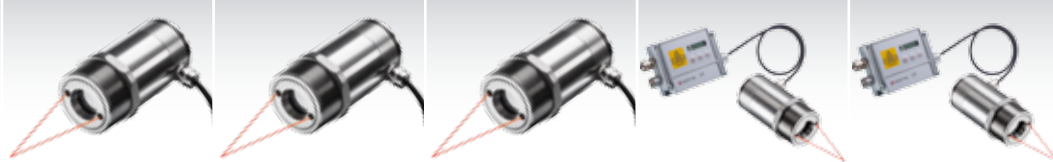

Base Model	CSlaser	CSlaser	CSlaser	CTlaser	CTlaser
Type	LT / hs LT	2M	G5HF	LT / LTF	05M
Classification / special features	Single-piece two-wire sensor with electronics in sensing head	Single-piece two-wire sensor with electronics in sensing head for measurement of metal	Single-piece two-wire infrared thermometer for temperature measurement of glass	Two-piece sensor with separate electronic box with fast response time, incl. programming keys and display	Two-piece sensor with separate electronic box for high temp. measurement of liquid metal, incl. programming keys and display
Detector	Thermopile	InGaAs	Thermopile	Thermopile	Si
Sensing head exchangeable	–	–	–	■	■
Head cable shortening	■	■	■	■ [max. 6 m]	■ [max. 6 m]
Thread (sensing head)	M48x1.5	M48x1.5	M48x1.5	M48x1.5	M48x1.5
Spectral range	8–14 µm	1.6 µm	5.0 µm	8–14 µm	0.525 µm
Temperature ranges	LT: –30 °C ... 1000 °C hs LT: –20 °C ... 150 °C	L: 250 °C ... 800 °C H: 385 °C ... 1600 °C	200 °C ... 1650 °C	–50 °C ... 975 °C	1000 °C ... 2000 °C
Temperature resolution	LT: 0.1 K / hs LT: 0.025 K	0.1 K	0.1 K	LT: 0.1 K / LTF: 0.5 K	0.2 K
Optical resolution	50:1	2MH: 300:1 2ML: 150:01	45:1	LT: 75:1 LTF: 50:1	150:1
Option: CF lens	–	–	–	–	–
Smallest spot (CF optics/ add. CF lens)	1.4 mm @ 70 mm	0.5 mm @ 150 mm	1.6 mm @ 70 mm	LT: 0.9 mm @ 70 mm LTF: 1.4 mm @ 70 mm	–
Smallest spot (SF optics)	24 mm @ 1200 mm	3.7 mm @ 1100 mm	27 mm @ 1200 mm	LT: 16 mm @ 1200 mm LTF: 24 mm @ 1200 mm	7.3 mm @ 1100 mm
Sighting	Double laser	Double laser	Double laser	Double laser	Double laser
Response time (90 %)	150 ms	10 ms	30 ms	LT: 120 ms / LTF: 9 ms	1 ms
Accuracy	±1 °C or ±1 %	±(0.3 % T _{meas} +2 °C)	±1% or ±1 °C	LT: ±1 °C or ±1 % LTF: ±1.5 °C or ±1.5 %	±(0.3 % T _{meas} +2 °C)
Outputs analog: 0–20 mA / 4–20 mA / 0–5 V / 0–10 V / t/c (K/J)	– / ■ / – / – / –	– / ■ / – / – / –	– / ■ / – / – / –	■ / ■ / ■ / ■ / ■	■ / ■ / ■ / ■ / ■
Second analog output	–	–	–	■	–
Interfaces: USB / RS232 / RS485 / Profibus / Ethernet	■ / – / – / – / –	■ / – / – / – / –	■ / – / – / – / –	■ / ■ / ■ / ■ / ■	■ / ■ / ■ / ■ / ■
Signal processing: Peak / Valley / AVG / Advanced hold	■ / ■ / ■ / ■	■ / ■ / ■ / ■	■ / ■ / ■ / ■	■ / ■ / ■ / ■	■ / ■ / ■ / ■
T _{Amb} Head min.	–20 °C	–20 °C	–20 °C	–20 °C	–20 °C
T _{Amb} Head max.	85 °C	85 °C	85 °C	85 °C	85 °C
T _{Amb} Electronics max.	85 °C	85 °C	85 °C	85 °C	85 °C
Functional inputs/ number	– / –	– / –	– / –	■ / 3	■ / 3
External emissivity adjustment	–	–	–	■	■
External background temperature control	–	–	–	■	■
Trigger input for reset of hold functions	–	–	–	■	■
Digital I/O pins/ number	–	–	–	–	–
Simultaneous analog and digital output	■	■	■	■	■
Alarm output as alternative to analog output	■	■	■	■	■
Additional alarm output/ switching output	■	■	■	■	■
Voltage supply	5–30 V DC	5–30 V DC	5–30 V DC	8–36 V DC	8–36 V DC
Standard cable length	3 m	3 m	3 m	3 m	3 m
Cable length options	8 / 15 m	8 / 15 m	3 m / 8 m / 15 m	8 / 15 m	8 / 15 m



CTlaser	CTlaser	CT XL	CTlaser	CTlaser	CTlaser	CTratio
1M / 2M	3M	3M	MT / F2 / F6	G5	P7	1M
Two-piece sensor with separate electronic box for high temp. measurement of metal, incl. programming keys and display	Two-piece sensor with separate electronic box for low temp. measurement of metal, incl. programming keys and display	Two-piece sensor with separate electronic box for laser applications, incl. programming keys and display (no laser)	Two-piece sensor with separate electronic box incl. progr. keys and display for measurement: MT: through flames F2: CO ₂ flame gas F6: CO flame gas	Two-piece sensor with separate electronic box for measurement of glass, incl. programming keys and display	Two-piece sensor with separate electronic box for measurement of plastic foils, incl. programming keys and display	Ratio pyrometer with separate electronic box for high temp. measurement of metal feat. glass fiber cable and laser, incl. programming keys and display
1M: Si / 2M: InGaAs	Extended InGaAs	Extended InGaAs	Thermopile	Thermopile	Thermopile	Si sandwich
■	■	–	■	■	■	–
■ [max. 6 m]	■ [max. 6 m]	■	■ [max. 6 m]	■ [max. 6 m]	■ [max. 6 m]	–
M48x1.5	M48x1.5	M30x1	M48x1.5	M48x1.5	M48x1.5	M18x1
1M: 1.0 µm 2M: 1.6 µm	2.3 µm	2.3 µm	MT: 3.9 µm / F2: 4.24 µm / F6: 4.64 µm	5.0 µm	7.9 µm	0.7 – 1.1 µm
1ML: 485 °C ... 1050 °C 1MH: 650 °C ... 1800 °C 1MH1: 800 °C ... 2200 °C 2ML: 250 °C ... 800 °C 2MH: 385 °C ... 1600 °C 2MH1: 490 °C ... 2000 °C	L: 50 °C ... 400 °C H: 100 °C ... 600 °C H1: 150 °C ... 1000 °C H2: 200 °C ... 1500 °C H3: 250 °C ... 1800 °C	H: 100 °C ... 600 °C H1: 150 °C ... 1000 °C H2: 200 °C ... 1500 °C H3: 250 °C ... 1800 °C	200 °C ... 1650 °C	L: 100 °C ... 1200 °C H: 250 °C ... 1650 °C HF: 200 °C ... 1650 °C	0 °C ... 710 °C	700 °C ... 1800 °C
0.1 K	0.1 K	0.1 K	0.1 K	0.1 K	0.5 K	0.1 K (> 900 °C)
L: 150:1 H: 300:1	L: 60:1 / H: 100:1 / H1-H3: 300:1	H: 100:1 H1-H3: 300:1	45:1	L/HF: 45:1 H: 70:1	45:1	40:1
–	–	–	–	–	–	–
0.5 mm @ 150 mm	0.5 mm @ 150 mm	0.5 mm @ 150 mm	1.6 mm @ 70 mm	1 mm @ 70 mm	1.6 mm @ 70 mm	7.7 mm @ 305 mm
3.7 mm @ 1100 mm	11 mm @ 1100 mm	11 mm @ 1100 mm	27 mm @ 1200 mm	17 mm @ 1200 mm	27 mm @ 1200 mm	31.3 mm @ 1143 mm
Double laser	Double laser	–	Double laser	Double laser	Double laser	Laser
1 ms	1 ms	1 ms	10 ms	L: 120 ms / H: 80 ms HF: 10 ms	150 ms	5 ms – 10 s
±(0,3% T _{meas} + 2 °C)	±(0,3% T _{meas} + 2 °C)	±(0,3% T _{meas} + 2 °C)	±1.5 °C or ±1 %	±1.5 °C or ±1 %	±1.5 °C or ±1 %	±(1% T _{meas} + 1 °C)
■ / ■ / ■ / ■ / ■	■ / ■ / ■ / ■ / ■	■ / ■ / ■ / ■ / ■	■ / ■ / ■ / ■ / ■	■ / ■ / ■ / ■ / ■	■ / ■ / ■ / ■ / ■	■ / ■ / ■ / ■ / –
–	–	–	■	■	■	–
■ / ■ / ■ / ■ / ■	■ / ■ / ■ / ■ / ■	■ / ■ / ■ / ■ / ■	■ / ■ / ■ / ■ / ■	■ / ■ / ■ / ■ / ■	■ / ■ / ■ / ■ / ■	– / – / – / – / –
■ / ■ / ■ / ■	■ / ■ / ■ / ■	■ / ■ / ■ / ■	■ / ■ / ■ / ■	■ / ■ / ■ / ■	■ / ■ / ■ / ■	■ / ■ / ■ / ■
–20 °C	–20 °C	–20 °C	–20 °C	–20 °C	–20 °C	–20 °C
85 °C	85 °C	85 °C	85 °C	85 °C	85 °C	250 °C
85 °C	85 °C	85 °C	85 °C	85 °C	85 °C	85 °C
■ / 3	■ / 3	■ / 3	■ / 3	■ / 3	■ / 3	– / –
■	■	■	■	■	■	–
■	■	■	■	■	■	–
■	■	■	■	■	■	■ (via I/O pins)
–	–	–	–	–	–	■ / 2
■	■	■	■	■	■	■
■	■	■	■	■	■	■
■	■	■	■	■	■	■ (via I/O pins)
8–36 V DC	8–36 V DC	8–36 V DC	8–36 V DC	8–36 V DC	8–36 V DC	8–36 V DC
3 m	3 m	3 m	3 m	3 m	3 m	3 m
8 / 15 m	8 / 15 m	–	8 / 15 m	8 / 15 m	8 / 15 m	6 / 10 / 15 / 22 m

Infrared video thermometers

Infrared video thermometers with vario focus and patented cross hair laser



Base Modell	CSvideo	CTvideo	CTvideo
Type	2M (L/H)	1M / 2M (L/H)	3M (L/H)
Classification / special features	Single-piece two wire sensor with electronics in sensing head, video camera and cross hair laser for measuring metal	Two-piece sensor with electronic box for high temperature measurement of metals, video camera and cross hair laser	Two-piece sensor with electronic box for low temperature measurement of metals, video camera and cross hair laser
Detector	InGaAs	1M: Si / 2M: InGaAs	Extended InGaAs
Sensing head exchangeable	–	[+CT 1M / 2M]	[+CT 3M]
Head cable shortening	■	[max. 6 m]	[max. 6 m]
Thread (sensing head)	M48x1.5	M48x1.5	M48x1.5
Spectral range	1.6 μm	1M: 1.0 μm / 2M: 1.6 μm	2.3 μm
Temperature ranges (scalable via software)	250 °C ... 800 °C (2ML) 385 °C ... 1600 °C (2MH)	485 °C ... 1050 °C (1ML) 650 °C ... 1800 °C (1MH) 800 °C ... 2200 °C (1MH1) 250 °C ... 800 °C (2ML) 385 °C ... 1600 °C (2MH) 490 °C ... 2000 °C (2MH1)	50 °C ... 400 °C (3ML) 100 °C ... 600 °C (3MH) 150 °C ... 1000 °C (3MH1) ¹⁾ 200 °C ... 1500 °C (3MH2) ¹⁾ 250 °C ... 1800 °C (3MH3) ¹⁾
Temperature resolution	0.1 K	0.1 K	0.1 K
Optical resolution	2MH: 300:1 / 2ML: 150:1	L: 150:1 / H: 300:1	L: 60:1 / H: 100:1 / H1 – H3: 300:1
Smallest spot (CF optics) CF vario optics: focusable from 90 mm to 250 mm	2ML: 0.6 mm @ 90 mm (CF) 2MH: 0.3 mm @ 90 mm (CF)	1ML/2ML: 0.6 mm @ 90 mm (CF) 1MH-H1/ 2MH-H1: 0.3 mm @ 90 mm (CF)	3ML: 1.5 mm @ 90 mm (CF) 3MH: 0.9 mm @ 90 mm (CF) 3MH1 – H3: 0.3 mm @ 90 mm (CF)
Smallest spot (SF optics) SF vario optics: focusable from 200 mm to infinity	2ML: 1.3 mm @ 200 mm (SF) 2MH: 0.7 mm @ 200 mm (SF)	1ML/2ML: 1.3 mm @ 200 mm (SF) 1MH-H1/ 2MH-H1: 0.7 mm @ 200 mm (SF)	3MH: 3.3 mm @ 200 mm (SF) 3MH: 2.0 mm @ 200 mm (SF) 3MH1 – H3: 0.7 mm @ 200 mm (SF)
Sighting	video camera and cross hair laser	video camera and cross hair laser	video camera and cross hair laser
Response time (90 %)	10 ms	1 ms	1 ms
Accuracy	$\pm(0.3\% T_{\text{meas}} + 2\text{ °C})$	$\pm(0.3\% T_{\text{meas}} + 2\text{ °C})$	$\pm(0.3\% T_{\text{meas}} + 2\text{ °C})$
Outputs analog: 0–20 mA / 4–20 mA / 0–5 V / 0–10 V / t/c (K/J)	– / ■ / – / – / –	■ / ■ / ■ / ■ / ■	■ / ■ / ■ / ■ / ■
Interfaces: USB / RS232 / RS485 / Profibus / Ethernet	■ / – / – / – / ■	■ / – / – / – / ■	■ / – / – / – / ■
Signal processing: Peak / Valley / AVG / Advanced hold	■ / ■ / ■ / ■	■ / ■ / ■ / ■	■ / ■ / ■ / ■
T _{Amb} Head min.	–20 °C	–20 °C	–20 °C
T _{Amb} Head max.	70 °C	70 °C	70 °C
T _{Amb} Electronics max.	70 °C	85 °C	85 °C
Functional inputs / number	– / –	■ / 3	■ / 3
External emissivity adjustment	–	■	■
External background temperature control	–	■	■
Trigger input for reset of hold functions	–	■	■
Simultaneous analog and digital output	■	■	■
Alarm output as an alternative to analog output	■	■	■
Additional alarm output	0–30 V / 500 mA (open-collector)	24 V / 50 mA (open-collector)	24 V / 50 mA (open-collector)
Voltage supply	5–28 V DC	8–36 V DC	8–36 V DC
Standard cable length	3 m	3 m	3 m
Cable length options	8 / 15 m	5 / 10 m	5 / 10 m

¹⁾ Specifications available for object temperatures \geq lower measurement range 50 °C

Software included

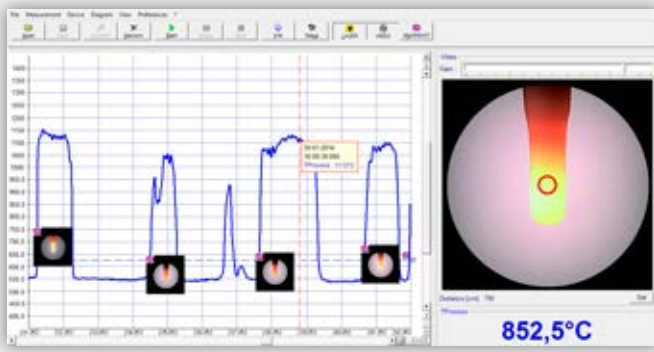

- Automatic snapshots (time or temperature dependent) to control and document the process
- Graphic display and recording of the measurement values
- Setup of sensor parameters and signal processing functions
- Remote control of the sensor

Connection options for CSvideo 2M

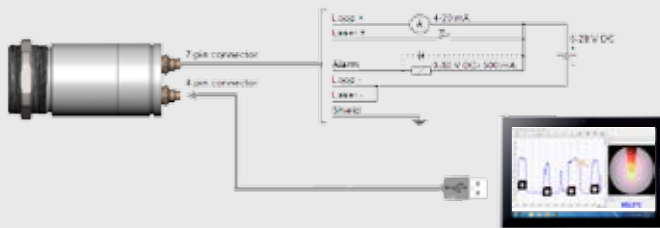

Analog operation mode: 4–20 mA and alarm interface. Setup & installation via USB cable (hot Plug & Play)



Digital operation mode: process control (video and temperature) via software

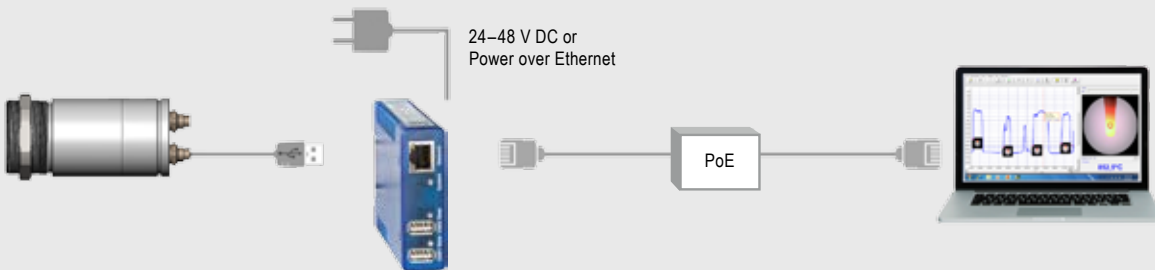

Connection options for CTvideo 1M / 2M / 3M

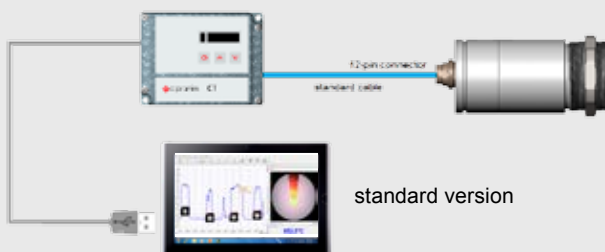

standard version

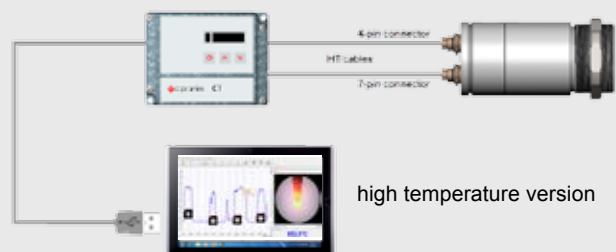

high temperature version

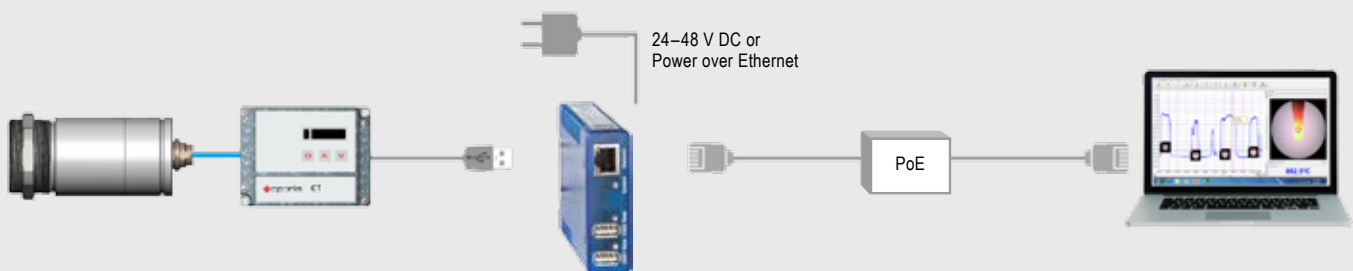

Infrared cameras

Compact infrared cameras for fast online applications, including line scanning



Base Model	PI 160	PI 200 / PI 230	PI 400 / PI 450
Type	IR	BI-SPECTRAL	IR
Detector	FPA, uncooled (25 µm x 25 µm)	FPA, uncooled (25 µm x 25 µm)	FPA, uncooled (25 µm x 25 µm)
Optical resolution	160 x 120 pixel	160 x 120 pixel	382 x 288 pixel
Spectral range	7.5–13 µm	7.5–13 µm	7.5–13 µm
Temperature ranges	–20 °C... 100 °C, 0 °C... 250 °C, (20) 150 °C... 900 °C ³⁾ , 200 °C... 1500 °C (Option) ¹⁾	–20 °C... 100 °C, 0 °C... 250 °C, (20) 150 °C... 900 °C ³⁾ , 200 °C... 1500 °C (Option) ¹⁾	–20 °C... 100 °C, 0 °C... 250 °C, (20) 150 °C... 900 °C ³⁾ , 200 °C... 1500 °C (Option) ¹⁾
Frame rate	120 Hz	128 Hz ⁴⁾	80 Hz / switchable to 27 Hz
Optics (FOV)	23° x 17° / f = 10 mm or 6° x 5° / f = 35.5 mm or 41° x 31° / f = 5.7 mm or 72° x 52° / f = 3.3 mm	23° x 17° ²⁾ / f = 10 mm or 6° x 5° / f = 35.5 mm or 41° x 31° ²⁾ / f = 5.7 mm or 72° x 52° / f = 3.3 mm	29° x 22° / f = 18,7 mm or 13° x 10° / f = 41 mm or 53° x 40° / f = 10.5 mm or 80° x 56° / f = 7.7 mm
Thermal sensitivity (NETD)	0.08 K with 23° x 17° FOV / F = 0.8 0.3 K with 6° x 5° FOV / F = 1.6 0.1 K with 41° x 31° FOV and 72° x 52° FOV / F = 1	0.08 K with 23° x 17° FOV / F = 0.8 0.3 K with 6° x 5° FOV / F = 1.6 0.1 K with 41° x 31° FOV and 72° x 52° FOV / F = 1	PI 400: 0,08 K with 29°, 53°, 80° FOV PI 450: 0,04 K with 29°, 53°, 80° FOV lenses mentioned above: F = 0,8 PI 400: 0,1 K with 13° FOV / F = 1,0 PI 450: 0,06 K with 13° FOV / F = 1,0
Option for visual camera (only for BI-SPECTRAL camera)	–	Optical resolution: 640 x 480 pixel Frame rate: 32 Hz ⁴⁾ Optics (FOV): PI 200: 54° x 40°, PI 230: 30° x 23°	–
Accuracy	±2 °C or ±2 %, whichever is greater	±2 °C or ±2 %, whichever is greater	±2 °C or ±2 %, whichever is greater
PC interface	USB 2.0 / optional USB to GigE (PoE) conversion	USB 2.0 / optional USB to GigE (PoE) conversion	USB 2.0 / optional USB to GigE (PoE) conversion
Process interface (PIF)	Standard PIF: 0–10 V input, digital input (max. 24 V), 0–10 V output Industrial PIF (option): 2 x 0–10 V inputs, digital input (max. 24 V), 3 x 0–10 V outputs, 3 x relay (0–30 V / 400 mA), fail-safe relay	0–10 V input, digital input (max. 24 V), 0–10 V output 2 x 0–10 V inputs, digital input (max. 24 V), 3 x 0–10 V outputs, 3 x relay (0–30 V / 400 mA), fail-safe relay	0–10 V input, digital input (max. 24 V), 0–10 V output 2 x 0–10 V inputs, digital input (max. 24 V), 3 x 0–10 V outputs, 3 x relay (0–30 V / 400 mA), fail-safe relay
Ambient temperature (T _{Amb})	0 °C... 50 °C	0 °C... 50 °C	PI 400: 0 °C... 50 °C / PI 450: 0 °C... 70 °C
Storage temperature	–40 °C... 70 °C	–40 °C... 70 °C	PI 400: –40 °C... 70 °C PI 450: –40 °C... 85 °C
Relative humidity	20–80 %, non-condensing	20–80 %, non-condensing	20–80 %, non-condensing
Dimensions / protection class	45 mm x 45 mm x 62 mm / IP 67 (NEMA 4)	45 mm x 45 mm x 62 mm / IP 67 (NEMA 4)	46 mm x 56 mm x 90 mm / IP 67 (NEMA 4)
Weight	195 g, incl. lens	215 g, incl. lens	320 g, incl. lens
Shock/vibration	Shock: IEC 60068-2-27 (25 g and 50 g) Vibration: IEC 60068-2-6 (sinus-shaped)/ IEC 60068-2-64 (broadband noise)	Shock: IEC 60068-2-27 (25 g and 50 g) Vibration: IEC 60068-2-6 (sinus-shaped)/ IEC 60068-2-64 (broadband noise)	Shock: IEC 60068-2-27 (25 g and 50 g) Vibration: IEC 60068-2-6 (sinus-shaped)/ IEC 60068-2-64 (broadband noise)
Tripod mount	¼-20 UNC	¼-20 UNC	¼-20 UNC
Voltage supply	via USB	via USB	via USB
Scope of supply (standard)	<ul style="list-style-type: none"> • USB camera with 1 lens • USB cable (1 m) • Table-top tripod • PIF cable with connecting terminal strip (1 m) • optris® PI Connect software package • Aluminium case 	<ul style="list-style-type: none"> • USB camera with 1 lens and BI-SPECTRAL technology • USB cable (1 m) • Table-top tripod • Focus tool • PIF cable with connecting terminal strip (1 m) • optris® PI Connect software package • Aluminium case 	<ul style="list-style-type: none"> • USB camera with 1 lens • USB cable (1 m) • Table-top tripod • PIF cable with connecting terminal strip (1 m) • optris® PI Connect software package • Aluminium case (PI400) • Robust hard shell case (PI 450)

¹⁾ Not available for 72° (PI 160 / 2xx), 80° (PI 4xx) and 90° (PI 640) lenses

³⁾ Accuracy statement effective from 150 °C

²⁾ For ideal combination of IR and VIS image, a 41° HFOV lens is recommended (PI 200). For the PI 230, a 23° lens is recommended.



PI 640	PI 450 / PI 640 G7	PI 1M	PI 05M
IR	IR	IR	IR
FPA, uncooled (17 µm x 17 µm)	FPA, uncooled PI 450 G7: 25 µm x 25 µm PI 640 G7: 17 µm x 17 µm	CMOS (15 µm x 15 µm)	CMOS (15 µm x 15 µm)
640 x 480 pixel VGA	PI 450 G7: 382 x 288 pixels PI 640 G7: 640 x 480 pixels	764 x 480 pixels @ 32 Hz 382 x 288 pixels @ 80 Hz (switchable to 27 Hz) 72 x 56 pixels @ 1 kHz 764 x 8 pixels @ 1 kHz (fast linescanning mode)	764 x 480 pixels @ 32 Hz 382 x 288 pixels @ 80 Hz (switchable to 27 Hz) 72 x 56 pixels @ 1 kHz 764 x 8 pixels @ 1 kHz (fast linescanning mode)
7.5 – 13 µm	7.9 µm	0.85 – 1.1 µm	500 nm ... 540 nm
-20 °C ... 100 °C, 0 °C ... 250 °C, (20) 150 °C ... 900 °C ³⁾ , 200 °C ... 1500 °C (Option) ¹⁾	200 °C ... 1500 °C	450 °C ⁵⁾ ... 1800 °C (27 Hz mode) 500 °C ⁵⁾ ... 1800 °C (80 Hz and 32 Hz mode) 600 °C ⁵⁾ ... 1800 °C (1 kHz mode)	900 °C ... 2000 °C (27 Hz mode) 950 °C ... 2000 °C (32 / 80 Hz mode) 1100 °C ... 2000 °C (1 kHz mode)
32 Hz * 125 Hz in sub-frame mode (640x120 pixels)	PI 450 G7: 80 Hz / switchable to 27 Hz PI 640 G7: 32 Hz / 125 Hz in subframe-mode (640x120 pixels)	Up to 1 kHz / 1ms real-time analog output (0 - 10 V) from 8 x 8 pixel (freely selectable)	Up to 1 kHz / 1ms real-time analog output (0 - 10 V) from 8 x 8 pixel (freely selectable)
33° x 25° / f = 18.7 mm or 15° x 11° / f = 41.5 mm or 60° x 45° / f = 10.5 mm or 90° x 64° / f = 7.7 mm	PI 450 G7: 29° x 22° (f = 18.7 mm) 13° x 10° (f = 41 mm) 53° x 40° (f = 10.5 mm) 80° x 56° (f = 7.7 mm) PI 640 G7: 33° x 25° (f = 18.7 mm) 15° x 11° (f = 41.5 mm) 60° x 45° (f = 10.5 mm) 90° x 64° (f = 7.7 mm)	FOV@764 x 480 px: 39° x 25° (f = 16 mm) 26° x 16° (f = 25 mm) 13° x 8° (f = 50 mm) 9° x 5° (f = 75 mm) FOV@382 x 288 px: 20° x 15° (f = 16 mm) 13° x 10° (f = 25 mm) 7° x 5° (f = 50 mm) 4° x 3° (f = 75 mm)	FOV@764 x 480 px: 26° x 16° (f = 25 mm) FOV@382 x 288 px: 13° x 10° (f = 25 mm)
75 mK	130 mK	< 1 K (700 °C) < 2 K (1000 °C)	< 2 K (1400 °C) for 27 Hz, 32 Hz, 80 Hz < 2.5 K (1400 °C) for 1 kHz
-	-	-	-
±2 °C or ±2 %, whichever is greater	±2 °C or ±2 %, whichever is greater	±1 % of reading (object temperature <1400 °C)	±1.5 % of reading
USB 2.0 / optional USB to GigE (PoE) conversion	USB 2.0 / optional USB to GigE (PoE) conversion	USB 2.0 / optional USB to GigE (PoE) conversion	USB 2.0 / optional USB to GigE (PoE) conversion
0 – 10 V input, digital input (max. 24 V), 0 – 10 V output	0 – 10 V input, digital input (max. 24 V), 0 – 10 V output	0 – 10 V input, digital input (max. 24 V), 0 – 10 V output	0 – 10 V input, digital input (max. 24 V), 0 – 10 V output
2 x 0 – 10 V inputs, digital input (max. 24 V), 3 x 0 – 10 V outputs, 3 x relay (0 – 30 V / 400 mA), fail-safe relay	2 x 0 – 10 V inputs, digital input (max. 24 V), 3 x 0 – 10 V outputs, 3 x relay (0 – 30 V / 400 mA), fail-safe relay	2 x 0 – 10 V inputs, digital input (max. 24 V), 3 x 0 – 10 V outputs, 3 x relay (0 – 30 V / 400 mA), fail-safe relay	2 x 0 – 10 V inputs, digital input (max. 24 V), 3 x 0 – 10 V outputs, 3 x relay (0 – 30 V / 400 mA), fail-safe relays
0 °C ... 50 °C	PI 450 G7: 0 °C ... 70 °C / PI 640 G7: 0 °C ... 50 °C	5 °C ... 50 °C	5 °C ... 50 °C
-40 °C ... 70 °C	PI 450 G7: -40 °C ... 85 °C PI 640 G7: -40 °C ... 70 °C	-40 °C ... 70 °C	-40 °C ... 70 °C
20 – 80 %, non-condensing	20 – 80 %, non-condensing	20 – 80 %, non-condensing	20 – 80 %, non-condensing
46 mm x 56 mm x 90 mm / IP 67 (NEMA 4)	46 mm x 56 mm x 90 mm / IP 67 (NEMA 4)	46 mm x 50 mm x 90 mm / IP 67 (NEMA 4) ⁶⁾	46 mm x 56 mm x 90 mm / IP 67 (NEMA 4) ⁶⁾
320 g, incl. lens	320 g, incl. lens	320 g, incl. lens	320 g, incl. lens
Shock: IEC 60068-2-27 (25 g and 50 g) Vibration: IEC 60068-2-6 (sinus-shaped)/ IEC 60068-2-64 (broadband noise)	Shock: IEC 60068-2-27 (25 g and 50 g) Vibration: IEC 60068-2-6 (sinus-shaped)/ IEC 60068-2-64 (broadband noise)	Shock: IEC 60068-2-27 (25 g and 50 g) Vibration: IEC 60068-2-6 (sinus-shaped)/ IEC 60068-2-64 (broadband noise)	Shock: IEC 60068-2-27 (25 g and 50 g) Vibration: IEC 60068-2-6 (sinus-shaped)/ IEC 60068-2-64 (broadband noise)
¼ -20 UNC	¼ -20 UNC	¼ -20 UNC	¼ -20 UNC
via USB	via USB	via USB	via USB
<ul style="list-style-type: none"> • USB camera with 1 lens • USB cable (1 m) • Table-top tripod • PIF cable with connecting terminal strip (1 m) • optris® PI Connect software package • Robust hard shell case 	<ul style="list-style-type: none"> • USB camera with 1 lens • USB cable (1 m) • Table-top tripod • PIF cable with connecting terminal strip (1 m) • optris® PI Connect software package • Robust hard shell case 	<ul style="list-style-type: none"> • USB camera with 1 lens • Lens cap incl. protective window • USB cable (1 m) • Table-top tripod • PIF cable with connecting terminal strip (1 m) • optris® PI Connect software package • Aluminium case • Optional: CoolingJacket, high temperature cable 	<ul style="list-style-type: none"> • USB camera with 1 lens • lens protection tube incl. protective window • USB cable (1 m) • Table tripod • PIF cable (1 m) incl. terminal block • Software package optris® PI Connect • Aluminum case • Optional: CoolingJacket, high temperature cable

⁴⁾ The following options can be set:
Option 1 (IR with 96 Hz at 160 x 120 px; VIS with 32 Hz at 640 x 480 px)
Option 2 (IR mit 128 Hz at 160 x 120 px; VIS with 32 Hz at 596 x 447 px)

⁵⁾ +75 °C higher start temperature for optics with focal length f = 50 mm, f = 75 mm

⁶⁾ Only applies when lens protection tube is used

Infrared cameras

EXPANSION OPTIONS



PI LightWeight – Radiometric aerial thermography

Features:

- IR inspection with up to 640x480 pixels and a thermal sensitivity of up to 40 mK for detecting smallest hotspots
- Fully radiometric system with high accuracy of $\pm 2\%$ / $\pm 2\text{ }^\circ\text{C}$ in every pixel
- 380g two-piece design: Allows independent use of IR camera with any Windows PC or tablet PC
- Radiometric on-board real-time recordings with USB 3.0 flash drive
- GPS and GoPro support
- Video recording with low motion blur through high frame rate (32 Hz/ VGA or 125 Hz/ VGA sub-frame mode)
- Free updates for Recording Box software
- Extensive, license-free analysis software PI Connect included (any number of measuring fields in any shape, snapshot function, hot- and cold spot analysis, temperature profiles etc)
- Remotely controlled recordings and switch between VIS and IR live video



PI NetBox

Features:

- Miniature PC as an add-on to the PI series for stand-alone system or for cable extension via GigE
- Integrated hardware and software watchdog
- Installation of additional user software possible
- Status LEDs
- Processor: Intel® E3845 Quad Core/ 1.91 GHz, 16 GB SSD, 2 GB RAM
- Connections: 2x USB 2.0, 1x USB 3.0, 1x Mini USB 2.0, Micro HDMI, Ethernet (Gigabit Ethernet), Micro SDHC/ SDXC card
- Operating system: Windows 7 Professional
- Wide supply voltage range (8–48 V DC) or Power over Ethernet (PoE)
- Can be integrated into CoolingJacket Advanced



USB Server Gigabit – for infrared cameras of optris® PI series

Features:

- Fully USB 2.0 compatible, Data rates: 1.5 / 12 / 480 mbps, USB transfer mode: Isochronous
- Network connection via Gigabit Ethernet
- For optris® PI series and optris® CTvideo/ CSvideo series
- Full TCP/IP support incl. routing and DNS
- Two independent USB ports
- Supply from PoE or external power supply with 24 – 48 V DC
- Galvanic isolation 500 V_{RMS} (network connection)
- Remotely configurable via Web Based Management
- Proven technology from Wiesemann & Theis



Industrial process interface (PIF)

Features:

- Industrial process interface with 3 analog/alarm outputs, 2 analog inputs, 1 digital input, 3 alarm relays
- 500 V_{AC}_{RMS} isolation voltage between camera and process
- Separate fail-safe relay output
- PI hardware including all cable connections and PI Connect software are permanently observed during operation

Connection options for PI LightWeight

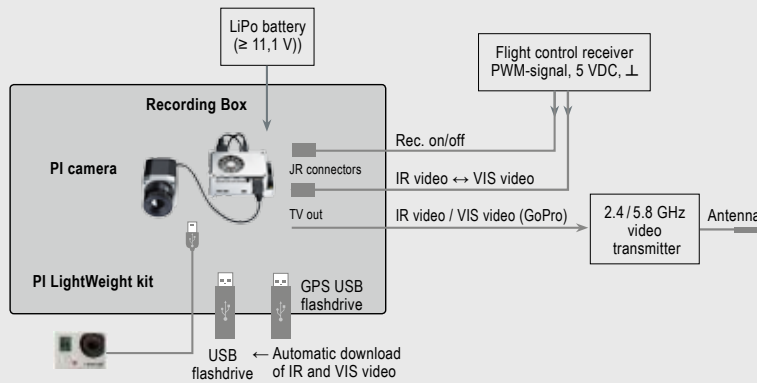

Connection options for PI NetBox

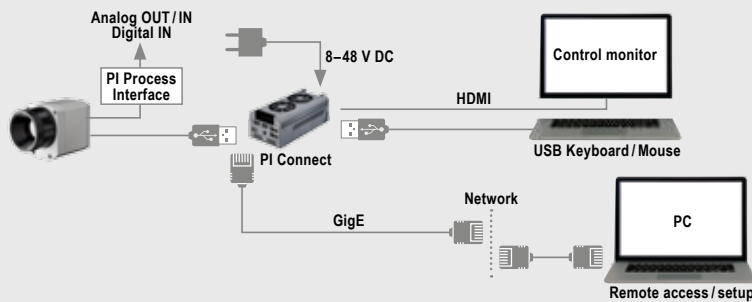

Connection options for USB Server Gigabit

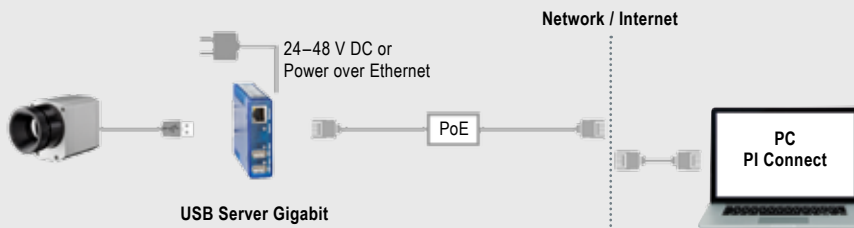

CoolingJacket Advanced

Features:

- Operation at ambient temperatures up to 315 °C
- Air/ water cooling with integrated air purging and optional protective windows
- Modular concept for easy installation of different devices and optics
- Trouble-free sensor disassembling on site with quick release chassis
- Integration of additional components like PI NetBox, USB Server Gigabit and Industrial Process Interface (PIF) in extended version



Outdoor protective housing for infrared cameras

Features:

- Environmental rating IP 66
- Additional air purge collar allows for a continuous operation in dusty and humid conditions
- Heating element and built-in fan enable for a 24/7 operation from -40 °C to 50 °C
- Installation of USB Server Gigabit and industrial process interface possible for integration into control systems over large outdoor distances

Software

1 Extensive infrared camera software

- No additional costs
- No restrictions in licencing
- Modern software with intuitive user interface
- Remote control of camera via software
- Display of multiple camera images in different windows
- Compatible with Windows 7, 8, 10 and Linux (ubuntu)
- Extensive license-free analysis and two Software Development Kits for Windows and Linux included



2 Extensive online and offline data analysis

- Real-time temperature information within main window as digital or graphic display
- Analysis supported by measurement fields, automatic hot and cold spot searching
- Logic operation of temperature information (measurement fields and image substraction)
- Slow motion repeat of radiometric files and analysis without camera being connected
- Editing of sequences such as cutting and saving of individual images
- Various color palettes to highlight thermal contrasts

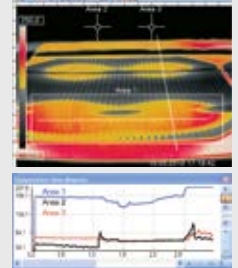

3 High level of individualization for customer

- Different layout options for an individual setup (arrangement of windows, toolbar)
- Temperature display in °C or °F
- Various language options including a translation tool
- Range of individual measurement parameters appropriate for each application
- Adaption of thermal image (mirror, rotate)
- Individual start options (full screen, hidden, etc.)

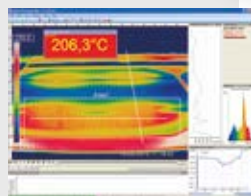

4 Automatic process and quality control

- Individual setup of alarm levels depending on the process
- BI-SPECTRAL process monitoring (IR and VIS) for easy orientation at point of measurement
- Definition of visual or acoustic alarms and analog data output via the process interface
- Analog and digital signal input (process parameter)
- External communication of software via Comports and DLL
- Adjustment of thermal image via reference values
- Measurement fields can be freely designed or created

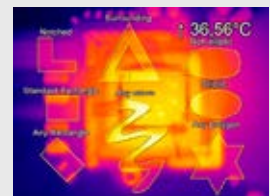

5 Video recording and snapshot function (IR or BI-SPECTRAL)

- Recording of video sequences and detailed frames for further analysis or documentation
- BI-SPECTRAL video analysis (IR and VIS) in order to highlight critical temperatures
- Adjustment of recording frequency to reduce data volume
- Display of snapshot history for immediate analysis

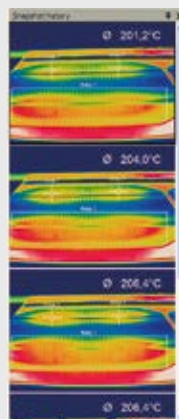

6 Temperature data analysis and documentation

- Triggered data collection
- Radiometric video sequences (*.ravi)
- Radiometric snapshots (*.tiff)
- Text files including complete temperature information for analysis in Excel (*.csv, *.dat)
- Data with color information for standard programs such as Photoshop or Windows Media Player (*.avi, *.tiff)
- Data transfer in real time to other software programs via DLL or Comport interfaces

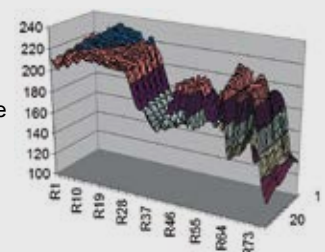

High-quality infrared thermometers with integrated USB interface



Base Model	LS	P20	P20	MS	MSPlus	MSPro
Type	LT	LT	1M / 2M / 05M	LT	LT	LT
Detector	Thermopile	Thermopile	Si / InGaAs	Thermopile	Thermopile	Thermopile
Spectral range	8 – 14 μm	8 – 14 μm	1M: 1.0 μm 2M: 1.6 μm 05M: 525 nm	8 – 14 μm	8 – 14 μm	8 – 14 μm
Temperature ranges	-35 °C ... 900 °C	0 °C ... 1300 °C	1M: 650 °C ... 1800 °C 2M: 385 °C ... 1600 °C 05M: 1000 °C ... 2000 °C	-32 °C ... 420 °C	-32 °C ... 530 °C	-32 °C ... 760 °C
Temperature resolution	0,1K	1 K	1 K	0.2K	0.1K	0.1K
Optical resolution	75:1	120:1	1M / 2M: 300:1 05M: 150:1	20:1	20:1	40:1
Switchable optics	■	-	-	-	-	-
Smallest spot (CF optics)	1 mm @ 62 mm	-	-	-	-	-
Smallest spot (SF optics)	16 mm @ 1200 mm	100 mm @ 12 m	1M / 2M: 12 mm @ 3.6 m 05M: 24 mm @ 3.6 m	13 mm @ 140 mm	13 mm @ 140 mm	13 mm @ 260 mm
Sighting	Cross hair laser	Double laser	Double laser	Laser	Laser	Laser
Response time (90 %)	150 ms	300 ms	100 ms	300 ms	300 ms	300 ms
Accuracy (at $T_{\text{Amb}} 23 \pm 5 \text{ } ^\circ\text{C}$)	$\pm 0.75\%$ (100 °C ... 900 °C) $\pm 0.75\text{ } ^\circ\text{C}$ (20 °C ... 99,9 °C) $\pm 1.5\text{ } ^\circ\text{C}$ (-20 °C ... 19,9 °C) $\pm 2.5\text{ } ^\circ\text{C}$ (-35 °C ... -20,1 °C)	$\pm 2\text{ } ^\circ\text{C}$ or $\pm 1\%$	$\pm (0.3\% T_{\text{meas}} + 2\text{ } ^\circ\text{C})$	$\pm 1\text{ } ^\circ\text{C}$ or $\pm 1\%$	$\pm 1\text{ } ^\circ\text{C}$ or $\pm 1\%$	$\pm 1\text{ } ^\circ\text{C}$ or $\pm 1\%$
PC interface	USB	USB	USB	USB	USB	USB
Software	■	■	■	■	■	■
Probe connection (t/c)	■	-	-	-	-	■
T_{Amb} Min. / Max.	0 °C / 50 °C	0 °C / 50 °C	0 °C / 50 °C	0 °C / 50 °C	0 °C / 50 °C	0 °C / 50 °C
Display MAX / MIN / HOLD	■	■	■	■	■	■
HIGH / LOW alarm	■	■	■	-	■	■
Data logger / capacity	■ / 100	■ / 2000	■ / 2000	-	-	■ / 20
Emissivity	0.100 ... 1.100	0.100 ... 1.100	0.100 ... 1.100	0.95 fixed	0.100 ... 1.100	0.100 ... 1.100

Best optics for portable thermometers

The optics of the portable thermometers are designed for mean distances. The **optris® LS LT** comes with a unique, **switchable lens** which means that smaller objects can be precisely measured in a close-up range.

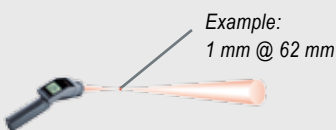

Close lens (CF, close focus): Measurement of smallest objects under test close to the sensor (only optris® LS LT)



Standard lens (SF, standard focus): Measurement of smallest objects under test in mean distances



Application fields

Laminating of vehicle interior



Vehicle interiors are partly equipped with different surface decors during a laminating process. The decor temperature is controlled and optimized during this time.

Product: optris® CSmicro LT

Production of glass syringes



During the production of glass syringes, the needle is glued to the glass tube. Punctual measuring pyrometers are used to monitor and control the process and ensure the quality of the syringes.

Product: optris® CTfast LT

Induction heating processes



Induction heating has acquired high importance within the area of heat treatment of metal. The aimed-for texture structure of the metal depends on the ideal temperature time process.

Product: optris® CTlaser 1M

Function tests of assembled circuit boards

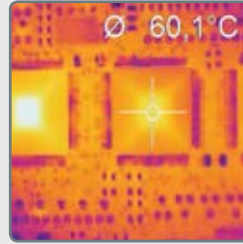

More and more manufacturers of electronic components and circuit boards are turning to the use of non-contact temperature measurement due to the increasing productivity of their components.

Product: optris® PI 450

Hot deforming of metals



Narrow temperature limits need to be met during hot deforming processes of metal. Handheld devices can be used for sporadic monitoring in forging and bending processes.

Product: optris® P20 2M

Preventive electrical maintenance



Almost every current asset which is supported by energy turns hot before a breakdown. Temperature monitoring can best be provided in line with preventive electronic maintenance.

Product: optris® LS LT